

**LECTURE NOTES**  
**ON**  
**Management Science**  
**(20A52701b)**

**IV B. Tech I Semester (R20)**

**Prepared by**

**Mrs.B.Veena, MBA.**  
**Assistant Professor**



**DEPARTMENT OF ELECTRICAL AND ELECTRONICS ENGINEERING**

**VEMU INSTITUTE OF TECHNOLOGY**

**NEAR PAKALA, CHITTOOR-517112, A.P**

**(Approved by AICTE, New Delhi & Affiliated to JNTUA, Anantapuramu)**



**JAWAHARLAL NEHRU TECHNOLOGICAL UNIVERSITY ANANTAPUR**  
**B.Tech (CE)– III-II Sem** **L T P C**  
**3 0 0 3**

**(20A52701b) MANAGEMENT SCIENCE**  
**(HUMANITIES ELECTIVE-II)**

**Course Objectives:**

- To provide fundamental knowledge on Management, Administration, Organization & its concepts.
- To make the students understand the role of management in Production
- To impart the concept of HRM in order to have an idea on Recruitment, Selection, Training & Development, job evaluation and Merit rating concepts
- To create awareness on identify Strategic Management areas & the PERT/CPM for better Project Management
- To make the students aware of the contemporary issues in management

**Course Outcomes:**

- Understand the concepts & principles of management and designs of organization in a practical world
- Apply the knowledge of Work-study principles & Quality Control techniques in industry
- Analyze the concepts of HRM in Recruitment, Selection and Training & Development.
- Evaluate PERT/CPM Techniques for projects of an enterprise and estimate time & cost of project & to analyze the business through SWOT.
- Create Modern technology in management science.

**UNIT I INTRODUCTION TO MANAGEMENT**

Management - Concept and meaning - Nature-Functions - Management as a Science and Art and both. Schools of Management Thought - Taylor's Scientific Theory-Henry Fayol's principles - Elton Mayo's Human relations - Systems Theory - **Organisational Designs** - Line organization - Line & Staff Organization - Functional Organization - Matrix Organization - Project Organization - Committee form of Organization - Social responsibilities of Management.

**UNIT II OPERATIONS MANAGEMENT**

Principles and Types of Plant Layout - Methods of Production (Job, batch and Mass Production), Work Study - Statistical Quality Control- Deming's contribution to Quality. **Material Management** - Objectives - Inventory-Functions - Types, Inventory Techniques - EOQ-ABC Analysis - Purchase Procedure and Stores Management - **Marketing Management** - Concept - Meaning - Nature-Functions of Marketing - Marketing Mix - Channels of Distribution - Advertisement and Sales Promotion - Marketing Strategies based on Product Life Cycle.

**UNIT III HUMAN RESOURCES MANAGEMENT (HRM)**

HRM - Definition and Meaning – Nature - Managerial and Operative functions - Evolution of HRM - Job Analysis - Human Resource Planning(HRP) - Employee Recruitment-Sources of Recruitment - Employee Selection - Process and Tests in Employee Selection - Employee Training and Development - On-the- job & Off-the-job training methods - Performance Appraisal Concept - Methods of Performance Appraisal – Placement - Employee Induction - Wage and Salary Administration

**UNIT IV STRATEGIC & PROJECT MANAGEMENT**

Definition & Meaning - Setting of Vision - Mission - Goals - Corporate Planning Process - Environmental Scanning - Steps in Strategy Formulation and Implementation - SWOT Analysis - **Project Management** - Network Analysis - Programme Evaluation and Review Technique (PERT) - Critical Path Method (CPM) Identifying Critical Path - Probability of Completing the project within given time - Project Cost- Analysis - Project Crashing (Simple problems).

**UNIT V CONTEMPORARY ISSUES IN MANAGEMENT**



## JNTUA B.Tech. R20 Regulations

The concept of Management Information System(MIS) - Materials Requirement Planning (MRP) - Customer Relations Management(CRM) - Total Quality Management (TQM) - Six Sigma Concept - Supply Chain Management(SCM) - Enterprise Resource Planning (ERP) - Performance Management - Business Process Outsourcing (BPO) - Business Process Re-engineering and Bench Marking - Balanced Score Card - Knowledge Management.

### **Textbooks:**

1. A.R Aryasri, "Management Science", TMH, 2013
2. Stoner, Freeman, Gilbert, Management, Pearson Education, New Delhi, 2012.

### **References:**

1. Koontz & Wehrich, "Essentials of Management", 6<sup>th</sup> edition, TMH, 2005.
2. Thomas N.Duening & John M.Ivancevich, "Management Principles and Guidelines", Biztantra.
3. Kanishka Bedi, "Production and Operations Management", Oxford University Press, 2004.
4. Samuel C.Certo, "Modern Management", 9<sup>th</sup> edition, PHI, 2005

# Management Science

---

## UNIT – I

### MANAGEMENT

#### **Introduction**

Management as a new discipline has drawn concepts and principles from number of disciplines such as economics, sociology, psychology, anthropology, and statistics and so on.

The result is that each group of contributors has treated management differently. For example, economists have treated management as a factor of production; sociologists have treated it as a class or group of persons; practitioners have treated it as a process comprising different activities. Naturally, all these divergent groups view the nature and scope of management from their own point of view. Thus, taking all these points of view together, it becomes difficult to define management in a comprehensive way. In the present context, the term management is used in three alternative ways:

1. Management as a discipline,
2. Management as a group of people, and
3. Management as a process.

#### **Management as a Discipline**

Discipline refers to a field of study having well-defined concepts and principles. When we refer to management as a discipline, we include in it the various relevant concepts and principles, the knowledge of which aids in managing.

#### **Management as a Group of People**

Sometimes, we refer to management as a group of people in which we include all those personnel who perform managerial functions in organizations.

#### **Management as a Process**

A process can simply be defined as systematic method of handling activities. However, the management process can be treated as a complex one which can be referred to as an identifiable flow of information through interrelated stages of analysis directed towards the achievement of an objective or set of objectives.

# Management Science

---

Historically, four orientations have been adopted in defining management process:

1. Production or efficiency oriented,
2. Decision-oriented,
3. People-oriented, and
4. Function-oriented.

## **Production or Efficiency-oriented Definitions**

In a similar way, **John Mee** has defined management in terms of securing maximum results when he views that:

“Management is the art of securing maximum results with minimum efforts so as to secure maximum prosperity and happiness for both employer and employee and give the public the best possible service.”

## **Decision-oriented Definitions**

A more formal decision-oriented definition of management has been provided by **Stanley Vance** as follows:

“Management is simply the process of decision making and control over the action of human beings for the expressed purpose of attaining pre-determined goals.”

## **People-oriented Definitions**

**Koontz** has defined management in similar way when he says that:

“Management is the art of getting things done through and with people in formally organised groups”.

## **Function-oriented Definitions**

**Henry Fayol**, he defined management as follows:

Management is a process involving planning, organising, staffing, directing, and controlling human efforts to achieve stated objectives in an organisation.

## **Importance of Management**

**1. Effective Utilization of Resources:** Management tries to make effective utilisation of various resources. The resources are scarce in nature and to meet the demand of the society. Management

# Management Science

---

not only decides in which particular alternative a particular resource should be used but also takes actions to utilise it in that particular alternative in the best way.

**2. Development of Resources:** Management develops various resources. This is true with human as well as non-human factors. It has emphasised that management is the development of people. Most of the researches for resource development are carried on in an organised way and management's involved in these organised activities. Thus, through the development of resources, management improves the quality of lives of people in the society,

**3. To Incorporate Innovations:** Today, changes are occurring at a very fast rate in both technology and social process and structure. These changes need to be incorporated to keep the organisations alive and efficient. Business organisations are moving from primitive to sophistication.

**4. Integrating Various Interest Groups:** In the organised efforts, there are various interest groups and they put pressure over other groups for maximum, share in the combined output.

**5. Stability in the Society:** Management provides stability in the society by changing and modifying the resources in accordance with the changing environment of the society. In the modern age, more emphasis is on new inventions for the betterment of human beings.

## Nature Of Management

1. Management—as a systematic process—helps identify a group of people who carry out particular activities, thereby improving an organization's efficiency and effectiveness. Here are the salient features that highlight the nature of management in businesses.
2. **Universality:** Management is a universal process and is essential for all organizations. If there is human activity, there is management. The principles of management are applicable irrespective of the size and location of a business. The universal principle also means that managerial skills can be developed over time and they're transferrable.
3. **Social Process:** The nature of management involves organizing people in groups and managing them. It requires different levels of empathy, understanding and dynamism. In

# Management Science

---

addition to taking care of social and emotional well-being, the process involves developing, motivating and retaining employees.

4. **Purposeful:** Management always has an end goal of achieving an organization's targets, mission and vision. The success of management can be measured by the extent to which an organization achieves its objectives. There is an underlying purpose of increasing efficiency and productivity. The objectives should be realistic, attainable and time-bound.
5. **Intangible:** There is no physical proof of the management process. Its success can be measured by the outcomes of its efforts. For example, lower turnover rates indicate there's high employee engagement and job satisfaction. This further shows that managers or individuals in managerial roles have taken proactive steps toward improving employee retention.
6. **Coordination:** Management coordinates all the functions of an organization by bringing together different teams and departments. Without coordination, there would be ambiguity and chaos. Therefore, by getting people on the same page, there is communication and minimized duplication of efforts.
7. **Creativity:** Management is made up of individual components and is a composite process. Every independent component contributes in unique ways. For example, group efforts encourage creative ideas and imagination. The sum of individual efforts creates synergy and something new is born.
8. **Dynamic Function:** Management should be dynamic at its core because businesses are often influenced by economic, social, political and technological factors. With room for flexibility and adaptability, individuals can perform well even in stressful situations. There should be adequate training and facilitation within the process.

## FUNCTIONS OF MANAGEMENT

1. **Planning:** when management is reviewed as a process, planning is the first function performed by a manager. The work of a manager begins with the setting of objectives of the organization and goals in each are of the business. This is done through planning. A

# Management Science

---

plan is a predetermined course of action to accomplish the set objectives, it is today's projection for tomorrow's activity. Planning includes objectives, strategies, policies, procedures, programs, etc. as it involves making choices; decision-making is the heart of planning.

2. **Organizing:** Organizing includes putting life into the plan by bringing together personnel, capital, machinery, materials, to execute the plans. While, planning decides what management wants to do. Organizing provides an effective machine for achieving the plans.
3. **Staffing:** Staffing involves filling the positions needed in the organization structure by appointing competent and qualified persons for the job. This needs manpower planning, scientific selection and training of personnel, suitable methods of remuneration and performance appraisal.
4. **Directing:** Direction involves managing managers, managing workers and the work through the means of motivation, proper leadership, effective communication as well as coordination. A manager must develop the ability to command and direct others.
5. **Motivating:** Motivation is a managerial function to inspire and encourage people to take required action. Motivation is the key to successful management of any enterprise. Motivation can set into motion a person carry out certain activity.
6. **Controlling:** Control is the process of measuring actual results with some standard of performance, finding the reason for deviations of actual from desired result and taking corrective action when necessary. Thus, controlling enables the realisation of plans. A manager must adopt the following steps in controlling:
  - Identify potential problems.
  - Select mode of control.
  - Evaluate performance in terms of planning.
  - Spot significant deviations.
  - Ascertain causes of deviations.
  - Take remedial measures.



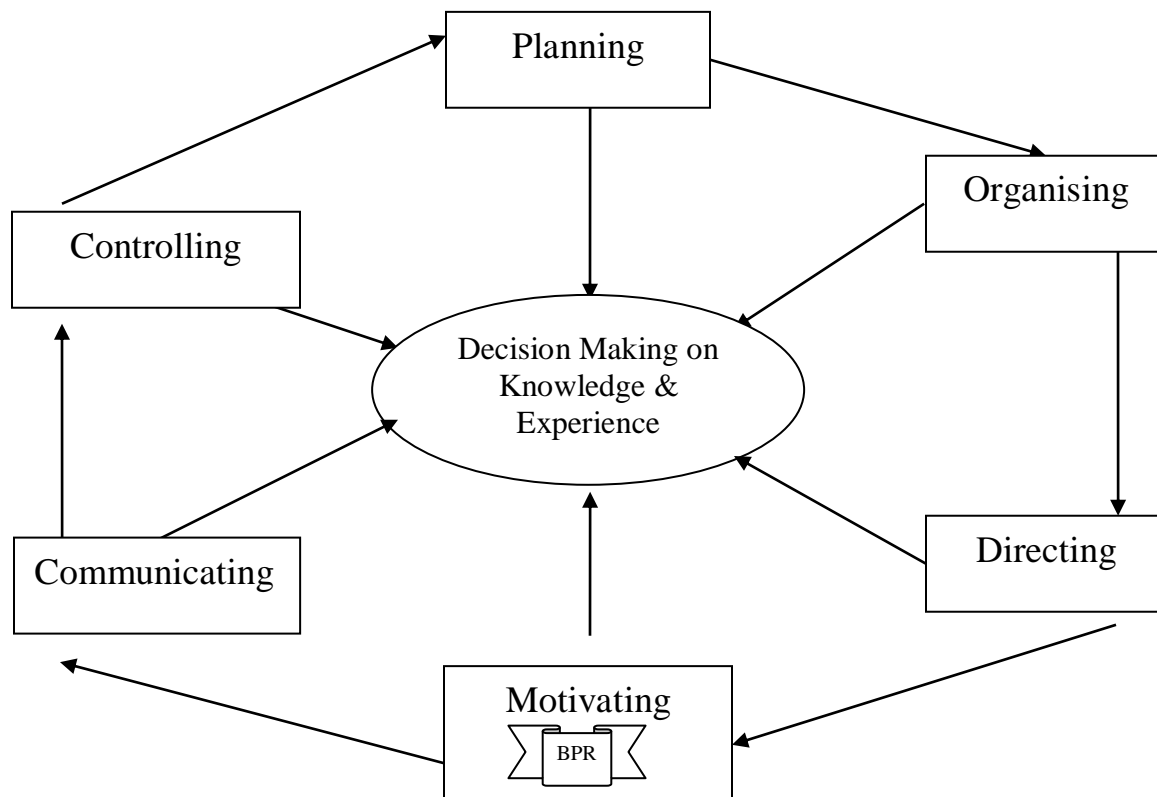

- Identify potential problems.
- Select mode of control.
- Evaluate performance in terms of planning.
- Spot significant deviations.
- Ascertain causes of deviations.
- Take remedial measures.

7. **Co-Ordination:** Co-ordination is concerned with harmonious and unified action directed toward a common object. It ensures that all groups and persons work efficiently, economically and in harmony. Co-ordination requires effective channels of communication. Person-to-person communication is most effective for co-ordination.

8. **Communication:** It means transfer of information and understanding from person to person. Communication also leads to sharing of information, ideas and knowledge. It enables group to think together and act together.

# Management Science

---

## MANAGEMENT AS A SCIENCE AND ART

### A. Management as a Science

Management is considered as a science because it has an organized body of knowledge which contains certain universal truth.

#### **Definition of science in management;**

*“Science is a systematic body of knowledge of data concerning a selected field of study that contains general facts which explain a phenomenon.”*

Science is the study and knowledge about the physical world and natural laws. These principles are developed through the scientific method of observation (experiments) and verification through testing.

**Features of Management as a science:** Management as a Science is characterized by the subsequent main features:

- 1. Universally acceptance principles:** Scientific principles represent basic truth about a few particular fields of inquiry. These principles may be applied in all situations, at all times & at all places.
- 2. Experimentation & Observation:** Scientific principles are derived through scientific investigation & research experiments. i.e. they are based on facts and logic.

Management principles are also based on scientific theory & observation. They have been developed through experiments & practical experiences of a large no. of managers and organizations.

*For Example,* it is observed that fair remuneration to personal helps in creating a satisfied workforce environment.

- 3. Cause & Effect Relationship:** Principles of science lay down cause and effect relationships between various variables.

*For Example,* if workers are given bonuses and fair wages then they will work hard. But the productivity of the organization will be reduced if they are not treated in a fair manner.

# Management Science

---

## B. Management as an Art

Management is an art because, in management, a manager applies his skills to manage and coordinate the effort of their people to perform his duties within the organization.

### Definition of Art in Management

*“Art refers to the application of knowledge (methods and principles) & skill to get desired results.”*

According to the definition of management, Management is the art of getting things done through and with people in an organization.

- This art may be defined as a personalized application of principles (accepted universally) for achieving the best possible results.
- Managerial art is the activity or skill of managing functions such as planning, organizing, leading, staffing, and controlling.
- The manager develops this art through his knowledge and experience of working in the organization.

### Features of Management as an Art

1. **Practical Knowledge:** Every art requires practical knowledge therefore learning of theory isn't sufficient. It's vital to understand the practical application of theoretical principles.

A manager can never achieve success just by obtaining a degree or diploma in management. He must have also known how to apply various principles in real situations by functioning within the capacity of a manager.

2. **Personal Skill:** Although the theoretical base may be the same for every artist (Manager), each one has his own style and approach towards his job (Skill). Management as an art is also personalized and every manager has his own way of managing things based on his knowledge, experience, and personality.
3. **Creativity:** Every artist has a component of creativity in line. That's why he aims at producing something that has never existed before which requires a mixture of intelligence & imagination.

# Management Science

---

Management is also dynamic and creative in nature like any other art. It combines human and non-human resources in a useful way so as to achieve desired goals.

- 4. Perfection through practice:** Practice makes a man perfect is a well-known proverb that simply means every artist becomes more and more proficient through constant practice.

Similarly, managers learn through the art of trial and error initially. But the application of management principles over the years makes them perfect in the job of managing and problem-solving.

- 5. Goal-Oriented:** Every art is result-oriented as it seeks to achieve desired results. In the same manner, management is also directed towards the accomplishment of pre-determined goals of the organization.

## Management as both Science and Art

Management is a science as well as an art. The above-mentioned points clearly reveal that management combines features of both sciences as well as art.

It is considered as a *science* because it has an organized body of knowledge (principles) which contains certain universal truth. It is called an *art* because managing requires certain skills which are the personal ability of managers.

Science and art with respect to management are not mutually exclusive but they are complementary to each other. (Like tea and biscuit, bread and butter, etc.).

## SCHOOLS OF MANAGEMENT THOUGHT

### 1. Administrative Management Theory

Henry fayol was born in 1841 at Constantinople in France. He graduated as mining engineer in 1860 from the national school of mining. After his graduation, he joined a French coal company as an engineer. After a couple of years, he was promoted as manager. He was appointed as general manager of his company in 1888, at that time the company suffered heavy losses and was nearly bankrupt. Henry fayol succeed in converting his company from near bankkruptcy to a strong financial position and a record of points and dividends over a long period. Fayol has given 14 principles of management with the intent to improve the functioning of the managers.

# Management Science

---

## Henry Fayol's 14 principles:

- 1. Division of work:** Division of among various individuals in the organisation necessary to bring about Specialisation in every activity. Management process should be based on the principle of Specialisation .Division of work or Specialisation alone can give maximum productivity and efficiency.
- 2. Authority and Responsibility:** Management consists of getting things done through others, a manager should have power to extract obedience from others, this is known as authority and it is derived from official status and is commensurate with responsibility.
- 3. Discipline:** Discipline means obedience to authority, respect for work and superiors. Discipline lends substantive meaning to managerial authority. Management's task of executing the work through coordinated efforts of personal depends to a large extent on the discipline in the rank and file.
- 4. Unity of command:** This principle requires that employee must receive orders from one superior for any action. Otherwise it may result in disorder, confusion and undermining of authority. Dual command leads to weakening of the organisation unless one of the superior is eliminated.
- 5. Unity of direction:** All members of organisation must accomplish common objectives. For every category of work, there should be one plan of action and executed under overall supervision of one superior.
- 6. Subordination of individual interest to the general interest:** According to this principle, the individual and organizational interest must coincide to get the task accomplished. The individual must not place his personal interest over the common interest.
- 7. Remuneration:** Fair pay with non-financial rewards can act as the best incentive or motivator for good performance. Sound scheme of remuneration includes adequate financial and non-financial incentives. Remuneration should enable the employees to lead a satisfactory life and addition offer special incentive to those who are more versatile or meritorious.

## Management Science

---

- 8. Centralisation & Decentralisation:** It means *concentration* of authority at one place or one level in the organisation. On the other hand *decentralisation* refers to the dispersal of authority to the lower levels in the organisation. Management has to decide to what extent the decision-making authority is to be centralized or decentralized. There must be balance between Centralisation and decentralisation authority and power. Extreme Centralisation and decentralization must be avoided.
- 9. Scalar chain:** The unity of command brings about a chain or hierarchy of command linking all members of organisation from top to the bottom. Scalar denotes steps. According to this principle, the authority flows from top level to lower level in a vertical manner. This is merely a chain of authority but also chain of communication from both top most executive to the lowest level executive and from lowest level to top level executive.
- 10. Order:** Order or system alone can create a sound organisation and efficient management. Orderliness in work can be obtained by the management through suitable organisation man and materials. Right man for right job and right materials for the right thing would ensure systematic utilization of man power and resources employed.
- 11. Equity:** An organisation consists of a group of people involved in joint effort. Hence, equity (i.e., justice) must be there. Without equity, we cannot have sustained and adequate joint collaboration. Equity ensures cordial relations between the management and labor.
- 12. Stability of tenure of personal:** This principle calls for lowest possible turnover of personal for well-being of organisation. Management should ensure security of job to the personnel. Employees with fear of loosing their jobs will not be motivated to turn out better work. On the other hand, employees who feel secure in their jobs will obviously show keener interest, enterprising initiative and bring out best results.
- 13. Initiative:** Initiative means capacity to think out original plans and execute them with full discretion. Innovations are possible only when employees are encouraged to take initiative and welcome any suggestions for improvement in the work.

**14. Esprit de corps:** esprit de corps is the foundation of a sound organization. Union is strength. But unity demands co-operation. Pride, loyalty and sense of belonging are responsible for good performance. This principle calls for harmonious human relations in the organisation.

## **2. Scientific theory of management**

The scientific theory of management focuses on individual efficiency and productivity. The father of this theory is Fredrick Winslow Taylor (1890-1940), from his text Principles of Scientific Management (1911). His proposal was to apply principles of the scientific method to the practice of management. His influence is such that the scientific theory of management is often referred to as “Taylorism.”

The scientific management theory focused on improving the efficiency of each individual in the organization. The major emphasis is on increasing the production through the use of intensive technology, and the human beings are just considered as adjuncts to machines in the performance of routine tasks. Therefore, more attention is required to be imposed on the standardization of working methods and hence the scientific management theory laid emphasis on this aspect.

The major principles of scientific management, given by Taylor, can be summarized as follows:

- Separate *planning from doing*.
- The *Functional foremanship* of supervision, i.e. eight supervisors required to give directions and instructions in their respective fields.
- *Time, motion and fatigue studies* shall be used to determine the fair amount of work done by each individual worker.
- Improving the working conditions and *standardizing the tools*, period of work and cost of production.
- Proper *scientific selection and training* of workmen should be done.
- The *financial incentives* should be given to the workers to boost their productivity and motivate them to perform well.

# Management Science

---

Thus, the scientific management theory focused more on mechanization and automation, i.e., technical aspects of efficiency rather than the broader aspects of human behavior in the organization.

### **3. Human Relations Theory**

The human relations theory was established by Elton Mayo (1924 - 1932), an Australian psychologist. He conducted a series of experiments at the Hawthorne plants in the 1920s. In these experiments, Mayo evaluated the attitudes and psychological reactions of workers in on-the-job situations. It began by examining the impact of illumination levels on worker productivity. Eventually, the study was extended through the early 1930s and addressed a broader range of workplace conditions.

The results, however, identified a unique identifier of group performance - attention. The control and experimental groups' performance improved irrespective of the environmental conditions.

Human Relations Theory focuses specifically on the individual's needs and resultant behaviors of individuals and groups. It takes an interpersonal approach to managing human beings. It presents the organization is made up of formal and informal elements.

The formal elements of an organization are its structure. The informal aspects of the organization include the interactions between individuals. In this way, the organization is a type of social system. This system should be managed to create individual job satisfaction and the resultant motivation of the individual.

The findings were as follows:

- Group dynamics (Social Factors) are important determinants of job performance and output.
- Groups have their own norms and beliefs, independent of the individual members.
- Individuals are not solely motivated by compensation. Perceived meaning and importance of ones work are the primary determinants of output.
- Employees prefer a cooperative attitude from superiors, rather than command and control.
- Communication between management and employees is essential to understand employee issues.



# Management Science

---

- Workplace culture sets production standards - despite standards set by managers.

The work of Mayo, through the Hawthorne studies, was instrumental in understanding the roles of group behavior and individual psychology in management practice.

## **System Theory of Management**

**Ludwig von Bertalanffy and others** introduced General System Theory of Management in 1968 in a publication “General System Theory: Foundations, Development, Applications”. The basic idea of this theory is that a system is better than the parts which mean, multiple parts/departments/subsystems/components work harmoniously to yield the optimal benefit to a larger system.

To understand this approach/theory, we must understand what a system is. A system is an interacting or interdependent group of items/individuals forming a unified whole. We all are in a system. If we say so, we can see systems almost everywhere. For instance our family works as a system, our body works as a system, a school is a system also. So all the parts , family members, elements in the school, departments etc. are interrelated and interdependent and work in that manner to form a body, a family, a school or an organization. All elements need to work together for a common purpose.

This theory suggests and advocates that any association or organization needs to be seen as a system as a whole rather than working in subsystems and units. This theory stays as the foundation of organizational development. This approach considers an organization as an open system consisting of various small interrelated and interdependent units or sub-systems.

## **Components of system approach theory of management**

A complete system comprises basically five components. They are:

1. Input
2. Process
3. Output
4. Feedback
5. Environment

# Management Science

---

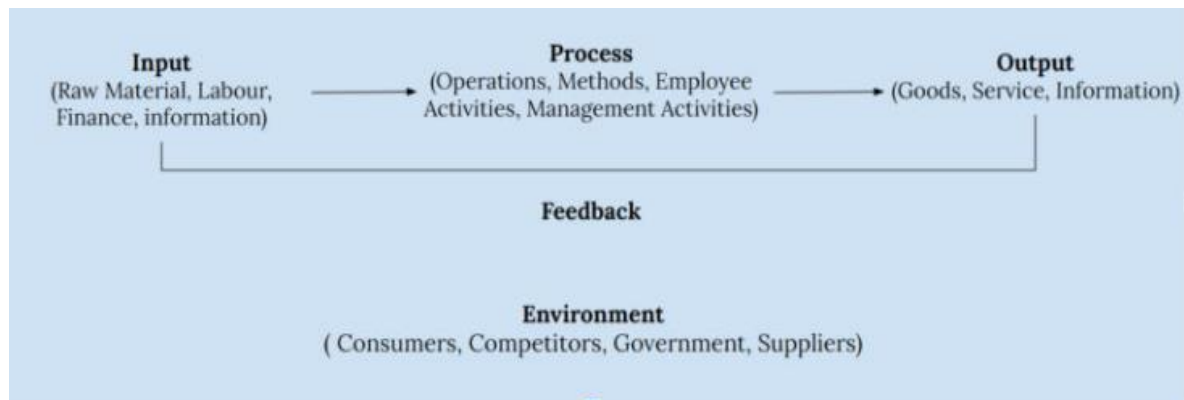

Fig: Components of System Approach Theory of Management

## Types of system

There are 2 types of systems:

1. Open System
2. Close System.

**Open System** interacts with its environment dynamically and also gets influenced by the external environment. All the organizations are open systems.

A **Closed System** is the opposite of an open system and doesn't get influenced by external environments and doesn't interact with them. These types of systems rarely do exist.

*The advantages* of the systems approach include:

- It assists in studying the functions of complex organizations
- It is probabilistic rather than deterministic.
- It has been utilized as the base for the new kinds of organizations like project management organization.

*The disadvantages* of the systems approach include:

- It can be difficult to apply to large and complex organizations.
- It does not provide any tool and technique for managers.
- It does not address power and social inequalities and their causes.
- It does not specify the nature of interactions and interdependencies

---

# Management Science

---

## ORGANISATIONAL DESIGNS

### A. Line Organization

Line organization structure is the oldest and simplest form of organization. In these organizations, a supervisor exercises direct supervision over a subordinate. Also, authority flows from the top-most person in the organization to the person in the lowest rung. This type of an organization is also called a military organization or a scalar-type organization.

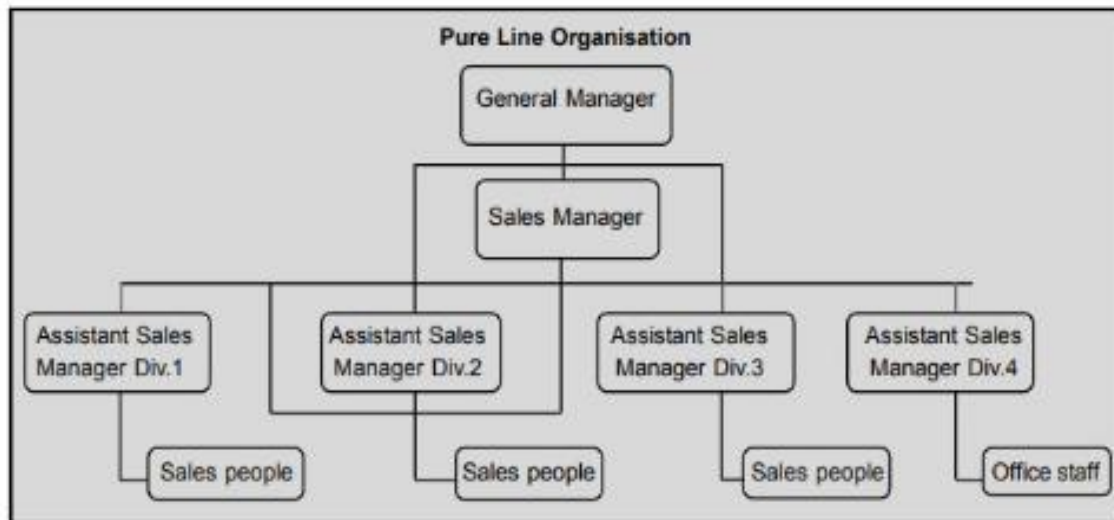

### Advantages of a Line Organization

- Simple to work
- Economical and effective. It also allows quick decisions and efficient coordination.
- Conforms to the scalar principle of organization. Further, it promotes the unity of command.
- In a line organization, the responsibility for the performance of tasks is fixed upon definite individuals. Therefore, there is accountability of delegated tasks.
- There is excellent discipline in a line organization due to unified control and undivided loyalties.

# Management Science

---

- The overall cost of running the organization is low due to the non-involvement of staff personnel.
- It is a stable form of organization.

## **Disadvantages of a Line Organization**

- A line organization can suffer from a lack of specialization. This is because each department manager is concerned only with the activities of his own department. Therefore, employees are skilled in tasks pertaining to their departments alone.
- These organizations can overburden a key-man or a few key-men to the extent of their breaking point. Also, in the absence of a staff aid, if a strong man seizes the organization, he can run it arbitrarily. Such arbitrary power can lead to a considerable damage to the organization.
- Such organizations usually suffer from a lack of expert advice. If the line manager has trouble making a decision, there is no expert staff that he can turn to.
- A line organization is usually rigid and inflexible. In fact, such organizations maintain discipline so rigorously that they can rarely change.
- These organizations are based on the autocratic system of management.
- The division of work is not based on any scientific plan but on the whims of the manager.
- It might stop progress and prevent the unit to work effectively.
- Such organizations might also encourage nepotism or favoritism based on relationship Or Friendship.

## **B. Line and Staff Organizational Structure**

A line and staff organization is an organizational structure in which authority is distributed vertically from top to bottom management, and specialists are attached to line managers to provide advice on key issues in the organization.

---

# Management Science

---

In this type of organization, two authorities exist, the line authority and the staff authority. The staff authority advises support and assists, line managers. The line authority, on the other hand, has the power to make major decisions in the organization.

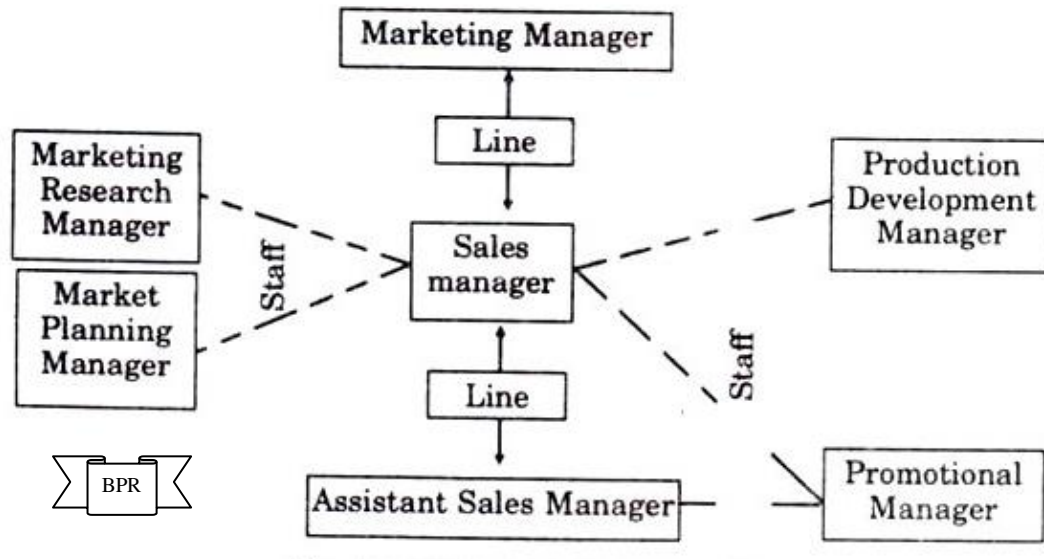

## Merits of Line and Staff Organisation:

1. There is a planned specialization.
2. There is a well defined authority and responsibility. The line of command is maintained.
3. There is bifurcation of conceptual and executive function.
4. The staff with its expert knowledge provides opportunities to the line officers for adopting a rational multidimensional view towards a problem.

## Demerits of Line and Staff Organisation:

1. There are bound to be occasions when line and staff may differ in opinion. This may result conflict of interest & prevents a harmonies relationship.
2. There is a misinterpretation of expert advice by incompetent line executives.
3. The staff people feel themselves status-less without authority.
4. Staff becomes ineffective in absence of authority.

---

# Management Science

---

## Comparisons of Line organization and line & staff organisation

Organization/features	Line organization	Line and staff organization
Presence of line authority	Yes	Yes
Presence of staff authority	No	Yes
Cost	Economical	Expensive
Suitable for	Small organizations	Large organisations
Expert advice	Absence	Present
Possibility of misunderstanding	No	Yes
The extent of discipline	Very strict	Loosed
Unity of command	Present	Present, but not as much as line organization

### C. Functional Organisational Structure

A functional structure divides the organization into departments based on their functions. Each is headed by a functional manager, and employees are grouped according to their roles. Functional managers typically have experience in the roles they supervise, ensuring that employees are using their skills effectively. A functional structure that maximizes department expertise helps companies achieve their business objectives.

Under a functional organizational structure, employees are classified according to their function in an organizational chart. This chart shows the role hierarchy (e.g., president, vice president, finance, sales, customer service, administration, etc.).

A functional structure divides the organization into departments based on their functions. Each is headed by a functional manager, and employees are grouped according to their roles. Functional managers typically have experience in the roles they supervise, ensuring that employees are using their skills effectively. A functional structure that maximizes department expertise helps companies achieve their business objectives.

# Management Science

---



Under a functional organizational structure, employees are classified according to their function in an organizational chart. This chart shows the role hierarchy (e.g., president, vice president, finance, sales, customer service, administration, etc.).

Each department has a head responsible for it, helping the organization control the consistency and quality of its performance. These department heads are skilled, experienced in the same work, and perform at a high level; accordingly, productivity is exceptional in a functional structure.

## **Advantages:**

1. As the employees are experts in that particular field, the work becomes more efficient and precise. Reduces the rate of mistakes as this could motivate the employees of the company.
2. Since every member comes from a similar background it allows them to share their thoughts and come up with better solutions. As sharing of knowledge is always beneficial.
3. The employees also can have a clear idea of the hierarchy and need not have to report or answer to several managers.

## **Disadvantages:**

1. It will lead to poor communication and coordination across functional units.

2. There will be lack of understanding across departments.
3. They focus more on their own goals and neglect the overall company objectives.
4. Communication in organizations with functional organizational structures can be rigid.

## D. Matrix Organisational Structure

A Matrix Organisational Structure doesn't follow the traditional, hierarchical model. In the matrix structure, you share resources and staff across teams and projects, as well as within departments or functions.

A matrix structure is a combination of two or more types of organisational structures. It is a way of arranging your business so that you set up reporting relationships as a grid, or a matrix, rather than in the traditional hierarchy.

In this structure, employees usually have **dual reporting relationships** - generally to their functional manager as well as the project manager. Typically, one reporting line will take priority over the other (eg staff may have to report to their functional manager before reporting to the project manager).

*Examples of matrix structure:* Different forms of matrix structure exist. These fall under three main categories, depending on the level of power of the project manager:

- **Functional or weak matrix** - the functional manager retains most of the power and is in charge of the people and resources. The project manager has a minimal role and tends to carry out administrative or coordinating tasks.
- **Strong matrix** - the project manager holds most of the power and authority controls the project budget and manages staff. The role of the functional manager is limited.
- **Balanced matrix** - the functional managers and the project managers share the power and the authority over staff and budget.

In large organizations, it is possible to involve all these types of matrix structure at different levels within a business. This is sometimes referred to as a 'composite organisation'.

### The advantages of a matrix organizational structure

- improve decision-making, since there are two chains of command



# Management Science

---

- help break down traditional 'silo' barriers
- improve communication across the business
- allow staff to apply their skills in different roles

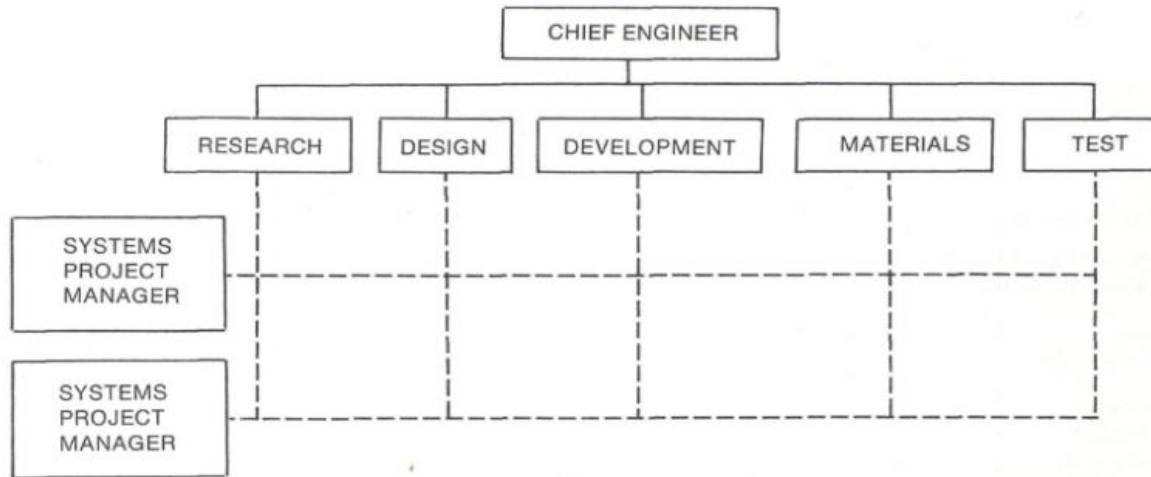

**Figure 1:** An engineering matrix organization

- help share best practice and ideas across teams
- increase efficiencies due to sharing resources across departments

## **The disadvantages of a matrix organisational structure**

- confusion regarding roles, responsibilities and priorities
- divided loyalties between project teams
- blurred lines of accountability
- difficulties in coordinating tasks or functions
- power struggle between the project manager and the functional manager
- large overhead costs, on account of having multiple managers

## **E. Project Organizational Structure**

Dedicated teams are put together to work on projects in a project organizational structure. The project manager probably has line management responsibility for the project team members. Examples of this would include large construction builds, but also corporate initiatives that require

# Management Science

---

a dedicated team. The project manager has ultimate authority, reporting to the project sponsor and the project board. The individuals on the team work directly for the project manager.

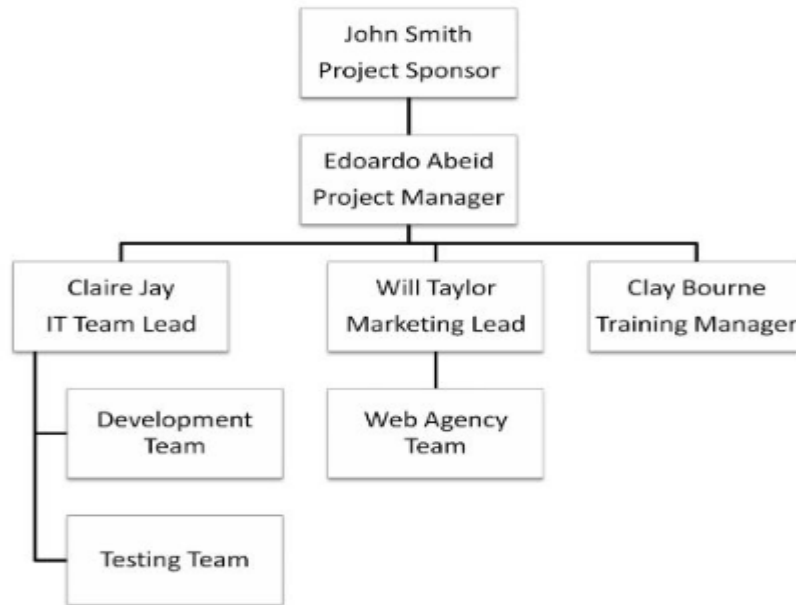

## Advantages

The obvious advantage of a project structure is that you have more control over the team, but other advantages are in place, too:

- Teams can have a strong sense of identity. It is the easiest structure within which to create a strong team culture.
- The whole team is focused on the team's goals, so conflict of loyalty exists with the day job for the people working on the project.
- Resources are dedicated to the project, so it's much easier to schedule work.
- Projects run in this structure are great environments for improving your project management skills as well as more technical leadership skills.

## Disadvantages

The project structure is the easiest to work with, but still has some drawbacks:

- Having a team dedicated to one project is an expensive commitment. It tends to be an option only on big projects.

# Management Science

---

- If you remove people from their functional jobs, they might find it difficult to go back, especially if the project is long.
- Sometimes closing a project can mean losing your job if the business has moved on and another role isn't available for you.
- Project managers in this type of structure do line management for their teams, too, which means spending time and effort on human resource tasks you wouldn't have to do in other structures.

## F. Committee organization Structure

A **committee organization** is an association of people set up to arrive at solutions to common problems. The line people are given opportunities to discuss their problems in the committee. The **committee organizational structure** is not like line or functional organization, but is similar to staff organization. Its decisions are implemented, whereas staff decisions are not necessarily implemented. It is a formal part of the organizational structure wherein the members are specifically mentioned.



For example, the Finance Committee will include all the functional managers, viz. Marketing Manager, Production Manager, Personnel Managers, etc. as members, and the Managing Director as the Chairman. It will decide the financial requirements of each and every department. The decisions taken by the committee are followed by the line people, as the committees are representatives of various functional departments.

## **Advantages of a Committee:**

1. A committee often performs worth-while tasks since two experts are better than one.
2. A committee coordinates the efforts of the departments which are represented (e.g., sales, production and engineering) in development of a new product.
3. A committee is of special value in broad policy determination and rounding out plans.
4. A committee reduces the work load of management.

## **Limitations of a Committee:**

1. Sometimes it turns out to be true that what a committee finishes in a week, a good individual may complete in a day.
2. It may be said that committee operations are slow and committees tend to hang on for a considerable time.
3. An executive afraid to stand behind his own decisions may use a rubber-stamp committee and thereby share his responsibility with others.
4. In a committee, no individual can be held responsible for anything.

## **Social Responsibility of Management**

Social responsibility is a moral obligation on a company or an individual to take decisions or actions that is in favour and useful to society. Social responsibility in business is commonly known as Corporate Social Responsibility or CSR.

## **Types of Social Responsibilities**

### *(1) Economic Responsibility*

- Every business is engaged in economic activities.
- So, the prime social responsibility of every business should be economic responsibility.
- Hence they should sell products and service which can satisfy the need of the society.

### *(2) Legal Responsibility*

- The company should comply with the political and legal environment of the country.
- The company should consider protecting the environment.

## *(3) Ethical Responsibility*

- This type of responsibility expects a certain type of behaviour or conduct from the company.
- This behaviour may not be documented by law.

## *(4) Discretionary Responsibility*

- These are voluntary actions taken by the entities in case of natural calamities, helping poor people etc.
- They help them by providing a charitable contribution, education activities etc.
- It prevents investments of charitable funds into speculative activities.

## **Social Responsibilities for Different Interest Groups**

### *(1) Responsibility towards the Shareholders*

- Shareholders are the owners of the company.
- The company should make all the efforts to maximize and protect shareholder's wealth.
- Sharing of useful information with the shareholders, utilization of funds etc.

### *(2) Responsibility towards the Workers*

- Workers are the key persons behind company success.
- Management of the enterprise must provide the proper working conditions to the workers.
- Workers should get fair salaries and wages.

### *(3) Responsibility towards the Consumers*

- It is the consumer who buys the company's product & services.
- So, it is the responsibility of the company to provide the right quality, right quantity with the right price to the consumer.
- There should not be the unfair trade practices like adulteration, poor quality, courtesy to the customers etc.

## (4) *Responsibility towards the Government & Community*

- Enterprises must follow the laws and regulations of the country/ state in which it is operating.
- The organisation should interact with society to know what they require.
- It should maintain proper infrastructure, proper disposal system and should not cause harm to the society in any manner.

## **Advantages of Social Responsibility**

- *Justification for existence and growth:* the business organisation keeps on providing good quality products. It's actually a fulfillment of social responsibility.
- *The long-term interest of the firm:* It can be noted that the public image of the business can be improved by focusing on social goals.
- *Maintenance of society:* The business should provide standard of living for the society.
- *Availability of resources with business:* These organizations have access to different types of resources. These resources should be used for fulfilling social responsibilities.
- *Holding business responsible for social problems:* Business activity should see if any type of activity is causing harm to society. The business should themselves held responsible and correct them.

## **Disadvantages of Social Responsibility**

- *Burden on consumers:* some business entities opt for these social responsibilities, they always try to shift their burden on ultimate consumers.
- *Lack of social skills:* Every business entity does not have enough skills and knowledge to solve each and every social problem.
- *Lack of broad public support:* Generally, society does not accept the involvement of business entities in social programs. That is why it gets difficult for the business to solve the problems without the participation of the public.

# Management Science

---

## UNIT II: OPERATIONS MANAGEMENT

### **Concept of plant layout**

Plant layout is a plan for effective utilisation of facilities for the manufacture of products; involving a most efficient and economical arrangement of machines, materials, personnel, storage space and all supporting services, within available floor space.

### **Definition**

*“Plant layout is a plan of optimum arrangement of facilities including personnel, equipment’s, storage space, material handling equipment and all other supporting services along with the decision of best structure to contain all these facilities.”*

### **Objectives**

- (i) Streamline flow of materials through the plant
- (ii) Minimise material handling
- (iii) Facilitate manufacturing progress by maintaining balance in the processes
- (iv) Maintain flexibility of arrangements and of operation
- (v) Maintaining high turnover of in-process inventory
- (vi) Effective utilisation of men, equipment and space
- (vii) Increase employee moral
- (viii) Minimise interference (i.e. interruption) from machines

### **Principles of Plant Layout:**

1. **Principle of Minimum Movement:** Materials and labor should be stimulated over minimum distances; saving cost and time of transportation and material handling.

# Management Science

---

2. **Principle of Space Utilization:** All available cubic space should be effectively utilized – both horizontally and vertically.
3. **Principle of Flexibility:** Layout should be flexible enough to be adaptable to changes required by expansion or technological development.
4. **Principle of Interdependence:** Interdependent operations and processes should be located in close proximity to each other; to minimize product travel.
5. **Principle of Overall Integration:** All the plant facilities and services should be fully integrated into a single operating unit; to minimize cost of production.
6. **Principle of Safety:** There should be in-built provision in the design of layout, to provide for comfort and safety of workers.
7. **Principle of Smooth Flow:** The layout should be so designed as to reduce work bottlenecks and facilitate uninterrupted flow of work throughout the plant.
8. **Principle of Economy:** The layout should aim at effecting economy in terms of investment in fixed assets.
9. **Principle of Supervision:** A good layout should facilitate effective supervision over workers.
10. **Principle of Satisfaction:** A good layout should boost up employee morale, by providing them with maximum work satisfaction.

## **Types of Plant layouts**

**1. Product or Line Layout:** Product Layout is also known as line layout. Various operations on raw material are performed in a sequence and machines are placed accordingly the production flow line.

This type of layout is preferable for continuous production that is, involving a continuous flow of in-process material towards the finished product stage.



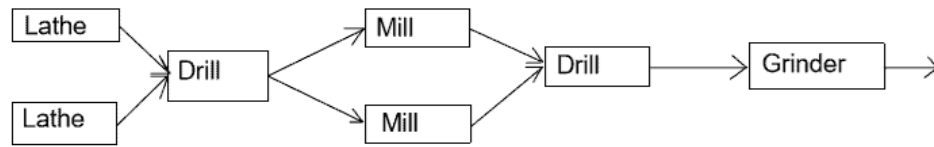

**Advantages of Product Layout:**

1. Lowers total material handling cost.
2. There is less work in processes.
3. Better utilization of men and machines

**Disadvantages of Product Layout:**

1. This layout is very less flexible for product change.
2. When single inspector has to look after many machines, inspection becomes difficult
3. Large capital investment, because of special purpose machines

**2. Process Layout:** In Process, layout keeps similar machines and similar operations in one place. In other words, machines are arranged according to their function. That means all lathe should be in one place, all milling at another and so on.

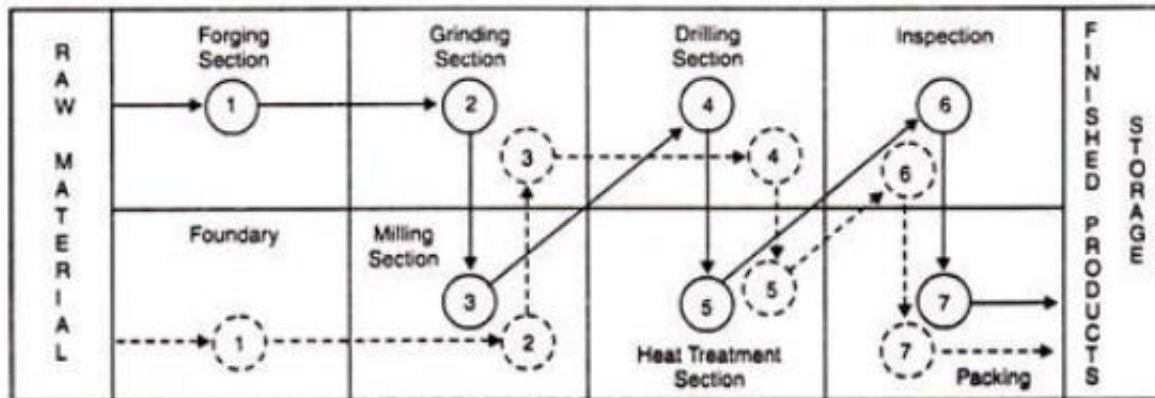

**Advantages of Process Layout:**

1. Better utilization of available equipment.
2. Less number of machines is required to do the operation.

## Disadvantages of Process Layout:

1. The process layout needs more space.
2. Automatic material handling is difficult.
3. Production control becomes difficult.

**3. Combination Layout:** A combination layout combines the advantages of both process layout and product layout. These days' pure process and product layouts are rare. A combination layout is possible where the item is made in different types and size.

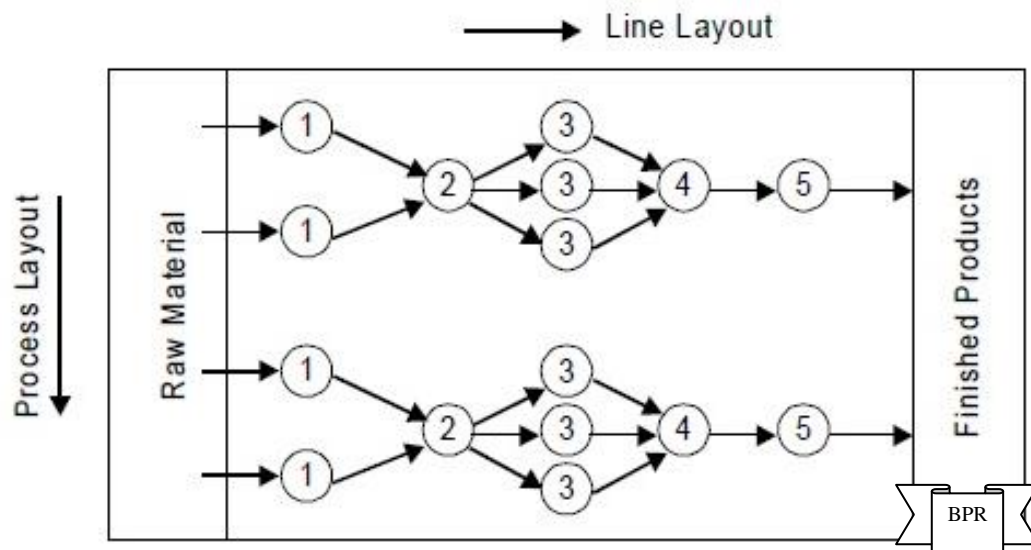

## Advantages of Combination Layout:

1. Reduction in cost of machine set-up time and material handling of metals.
2. Elimination of excess work-in-process inventory which subsequently allows the reduction in lot size.
3. Simplification of production planning functions, etc.

## Disadvantages of Combination Layout:

1. Change of the existing layout is time consuming and costly.
2. Inclusion of new components in the existing component requires thorough analysis.
3. Change of input component mix may likely to change complete layout structure.

# Management Science

---

4. **Fix Position Layout:** In this type of layout the major component remain in a fixed location, other materials, parts, tools, machinery, man power and other supporting equipment's are brought to this location.

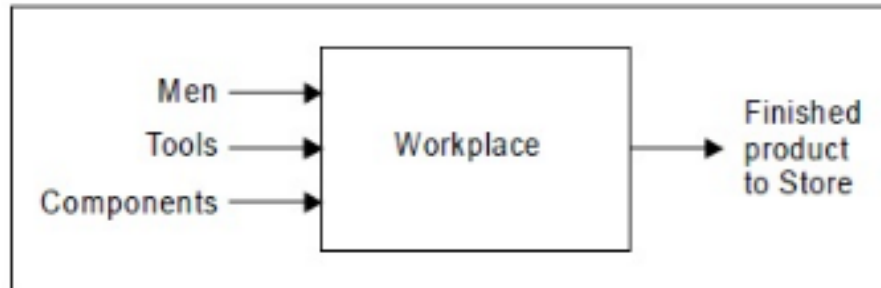

## **Advantages of Fixes Position layout:**

1. It is possible to assign one or more skilled workers from the start of a project to finish in order to ensure continuity of work.
2. Involves the least movement of materials, manufacturing of large size product is possible.
3. A number of quite different projects can be taken with the same layout.

## **Disadvantages of Fixed position layout:**

1. It involves a low content of work in progress.
2. It involves high equipment handling costs.

## **Types of Production Methods**

1. **Job Production:** It is where a single product is made at a time. The product is mostly based on the requirements of the customer. Job production tends to be labor intensive, and often highly skilled labor is required. Examples include building ships, bridges and buildings, handmade crafts like furniture and made-to-measure clothes.

### **Advantages:**

1. Unique, high quality products are made.

# Management Science

---

2. Workers are often more motivated and take pride in their work.
3. Production is easy to organize.

## **Disadvantages:**

1. Very labor intensive, so selling prices are usually higher.
2. Production can take a long time and can be expensive.

2. **Batch Production:** In this type of production, products are made in batches. For example, a shoe factory could make different batches of shoes based on the size and color of them.

## **Advantages:**

1. Since larger numbers are made, unit costs are lower.
2. Offers the customer some variety and choice.
3. Materials can be bought in bulk, so they are cheap.
4. Production is flexible since different batches are made.

## **Disadvantages:**

1. Expensive to move products around the workplace.
2. Storage space will be needed to store raw materials.

3. **Mass (Flow) Production:** In mass production, large numbers of identical products are made. Production is often continuous, and is suited to high demand, mass market products. Examples include cars, chocolate bars, and electronic goods.

## **Advantages:**

1. Labour costs are usually lower.
2. Large number of goods is produced.
3. Unit costs are relatively low.

## **Disadvantages:**

1. Machinery is very expensive to buy
2. Maintenance costs are very high.
3. Expensive at first place.

# Management Science

---

4. **Process Production:** Potential goods are produced in sets. These products are similar but are different in some respects (color or design) after one set is done workers re-set the machines to make a different batch.

## **Advantages:**

1. Provides variety for customers, which attracts them towards the business.

## **Disadvantages:**

1. Changing designs slows down production.
2. A gap in production causes the company to lose money.

## **WORK STUDY**

### **Meaning**

*According to International Labour Organization (ILO): work study is “a term used to embrace the techniques of method study and work measurement which is employed to ensure the best possible use of human and material resources in carrying out a specified activity.*

*”In other words, “work study is a tool or technique of management involving the analytical study of a job or operation.” Work study helps to increase productivity.*

### **Objectives of Work Study:**

1. Work study brings higher productivity
2. It eliminates wasteful elements;
3. It sets standard of performance;
4. It helps to use plant and human more effectively
5. It improves by saving in time and loss of material also.

### **Techniques of Work Study**

**Work Study** is encompassed by two techniques -method study and work measurement (time study):

1. **Method study** is the systematic recording and critical examination of existing and proposed ways of doing work, as a means of developing and applying easier and methods and reducing costs.
2. **Work measurement** (or Time study) is the application of techniques designed to establish the time for a qualified worker to carry out a specified job at a defined level of performance.

There is a close link between method study and work measurement. *Method study* is concerned with the reduction of the work content and establishing the one best way of doing the job whereas *work measurement* is concerned with investigation and reduction of any ineffective time associated with the job and establishing time standards for an operation carried out as per the standard method.

## Importance of Work Study

- Work study is a means of enhancing the production efficiency (productivity) of the firm by elimination of waste and unnecessary operations.
- It is a technique to identify non-value adding operations by investigation of all the factors affecting the job.
- It is the only accurate and systematic procedure oriented technique to establish time standards.
- It is going to contribute to the profit as the savings will start immediately and continue throughout the life of the product.

## Steps Involved in Work Study

1. SELECT Job or Process to be studied;
2. RECORD all the details concerning job using various recording techniques;
3. EXAMINE recorded facts critically by asking questions like who, what, when, why;
4. DEVELOP most economical method;
5. MEASURE the amount of work involved and set standard time to do that job;
6. DEFINE new method and standard time;
7. INSTALL the new method as a standard practice;
8. MAINTAIN new method as agreed standard.

# Management Science

---

## Statistical Quality Control (SQC)

Today market is highly competitive, the main objective of manufacturers or producers is to achieve quality assurance in manufacturing and service organizations. In order to achieve this objective, different statistical tools have been developed, which are useful for controlling the quality of product specifications or standards. The technique of using statistical tools for controlling product quality specification is known as *Statistical Quality Control (SQC)*.

### Definition

*“Statistical quality control is defined as the technique of applying statistical methods based on the theory of probability and sampling to establish quality standard and to maintain it in the most economical manner.”*

### Elements of SQC

1. **Sample Inspection:** In sampling inspection method, some items or units (called sample) are randomly selected from the process and then each and every unit of the sample is inspected.
2. **Use of Statistical Methods:** Statistical tools such as random sampling, mean, range, standard deviation, mean deviation, standard error and concepts such as probability, binomial distribution, Poisson distribution, normal distribution, etc., are used in SQC.
3. **Fundamental Objective:** The fundamental objective of SQC is to decide whether the unit produced is according to its specifications or not. If the unit produced is not according to its specifications and there is a variation in quality, it becomes necessary to trace the causes of variation and eliminate them if possible
4. **Decision Making:** With the help of SQC, we decide whether the quality of the product or the process of manufacturing/producing goods is under control or not.
5. **Specifications, Production and Inspection:** SQC method helps in deciding about the specifications, production and inspection of a product.

## Types of Quality Control:

The quality of a product manufactured in a factory may be controlled by the following two ways: i) Process Control ii) Product Control

1. **Process Control:** In this process, the quality is controlled while the product being produced remains in process of production. It ensures that the goods produced conform to the pre-determined quality standards. It controls the quality of goods to be produced by stopping production if the quality level is not being maintained. As the process control involves the use of control charts, therefore, this method is sometimes called the control chart technique
2. **Product or Lot Control:** It refers to the type of quality control of the product which has already been manufactured and which waits for sale and dispatch. . In this process, lot by lot sampling techniques inspection is performed and a lot is accepted or rejected on the basis of information obtained by sampling.

## Advantages of SQC:

1. **Reduction in cost:** Since only a fractional output is inspected, hence cost of inspection is greatly reduced.
2. **Greater efficiency:** It requires lesser time and boredom as compared to the 100 percent inspection and hence the efficiency increases.
3. **Easy to apply:** Once the S.Q.C plan is established, it is easy to apply even by man who does not have extensive specialized training.
4. **Accurate prediction:** Specifications can easily be predicted for the future, which is not possible even with 100 percent inspection.
5. **Can be used where inspection is needs destruction of items:** In cases where destruction of product is necessary for inspecting it, 100 percent inspection is not possible (which will spoil all the products), sampling inspection is resorted to.



6. **Early detection of faults:** The moment a sample point falls outside the control limits, it is taken as a danger signal and necessary corrective measures are taken

### **Disadvantages of SQC:**

1. It cannot be indiscriminately applied as a solution to all quality evils.
2. Implementation of statistical quality control is a costly Endeavour.
3. A false sense of security is created in absence of general awareness.

### **DEMING'S CONTRIBUTION TO QUALITY**

William Edwards Deming (1900-1993) is acknowledged as the leading management thinker in the field of quality. He was a statistician and business consultant whose methods helped Japanese to recover after the Second World War and beyond.

Deming created 14 points which provide a framework to developing knowledge in the workplace and can be used to guide long term business plans and aims.

1. ***Create constancy of purpose toward improvement of product and service***, with the aim of becoming competitive, staying in business and providing jobs.
2. ***Adopt the new philosophy***. Western management must awaken to the challenge, must learn their responsibilities and take on leadership for change.
3. ***Cease dependence on mass inspection***. Build quality into the product from the start.
4. ***End the practice of awarding business on the basis of price tag alone***. Instead, minimize total cost. Move towards a single supplier for any item, based on a long-term relationship of loyalty and trust.
5. ***Improve constantly and forever*** the system of production and service to improve quality and reduce waste.
6. ***Institute training and retraining***.
7. ***Institute leadership***. The aim of supervision should be to lead and help people to do a better job.

# Management Science

---

8. ***Drive out fear*** so that everyone may work effectively for the company.
9. ***Break down barriers between departments***. People in research, design, sales and production must work as a team, to foresee and solve problems of production.
10. ***Eliminate slogans, exhortations and targets*** for the workforce as they do not necessarily achieve their aims.
11. ***Eliminate numerical quotas in order to take account of quality and methods***, rather than just numbers.
12. ***Remove barriers to pride of workmanship***.
13. ***Institute a vigorous program of education and re-training*** for both the management and the workforce.
14. ***Take action to accomplish the transformation***. Management and workforce must work together.

## MATERIALS MANAGEMENT

Materials management is concerned with planning, directing and controlling the kind, amount, location, movement and timing of various flows of materials used in and produced by the process.

Materials management is defined as “*the function responsible for the coordination of planning, sourcing, purchasing, moving, storing and controlling materials in an optimum manner so as to provide a pre-decided service to the customer at a minimum cost*”

### **Objectives of Materials Management**

1. Procurement of materials at lowest prices.
2. High rate of inventory turnover.
3. To ensure continuity of supply.
4. To maintain the consistency of quality.
5. To minimize the acquisition & storing cost.
6. Lower administrative cost.

# Management Science

---

7. Maintenance of supplier relations.
8. Development of new materials & sources.
9. Efficient reporting.
10. Development of personnel

## Scope of Materials Management

1. Materials Planning
2. Production Control
3. Inventory Control
4. Purchase
5. Receiving & Inspection
6. Store Keeping
7. Shipping – Distribution of finished goods
8. .Materials Handling
9. Traffic / Transport
10. Physical Distribution ( to customers)Scrap Control

## INVENTORY CONTROL

### Meaning of Inventory:

Inventory means all the materials (may be raw or finished parts/components, in process or finished products, castings and consumable tools, electrodes etc.)

### Functions or Characteristics of Inventory

1. **Inventories Serve as Cushions:** Against shocks due to demand/supply fluctuations, it separates different manufacturing operations from one another and makes them independent so that each operation can be performed economically.
2. **Inventory, a Necessary Evil for Any Enterprise:** Inventories require valuable space, capital and other overheads for maintaining it. The invested capital remains idle till the stocks are not consumed.

# Management Science

---

3. **Inventory Provides Production Economies:** Purchase in desired quantities nullifies the effects of change in prices or supply. Stocks bring economy so purchase of various inputs due to discounts on bulk purchase.
4. **Maintenance of Smooth and Efficient Production Flow:** Maintains smooth and efficient production flow thus keeps a process continually operating.
5. **Creation of Motivational Effect in Decision Making:** Creates motivational effect in decision and policy making e.g. a person may be tempted to purchase more if inventories are displayed in bulk.

## Types of Inventory

1. **Raw Materials:** Raw materials are the materials a company uses to create and finish products. When the product is completed, the raw materials are typically unrecognizable from their original form, such as oil used to create shampoo.
2. **Components:** Components are like raw materials in that they are the materials a company uses to create and finish products, except that they remain recognizable when the product is completed, such as a screw.
3. **Work In Progress (WIP):** WIP inventory refers to items in production and includes raw materials or components, labor, overhead and even packing materials.
4. **Finished Goods:** Finished goods are items that are ready to sell.
5. **Maintenance, Repair and Operations (MRO) Goods:** MRO is inventory — often in the form of supplies — that supports making a product or the maintenance of a business.
6. **Packing and Packaging Materials:** There are three types of packing materials. Primary packing protects the product and makes it usable. Secondary packing is the packaging of the finished good and can include labels or SKU information. Tertiary packing is bulk packaging for transport.

# Management Science

---

7. **Safety Stock and Anticipation Stock:** Safety stock is the extra inventory a company buys and stores to cover unexpected events. Safety stock has carrying costs, but it supports customer satisfaction. Similarly, anticipation stock comprises of raw materials or finished items that a business purchases based on sales and production trends. If a raw materials price is rising or peak sales time is approaching, a business may purchase safety stock.
8. **Cycle Inventory:** Companies order cycle inventory in lots to get the right amount of stock for the lowest storage cost. Learn more about cycle inventory formulas in the “Essential Guide to Inventory Planning.”
9. **Service Inventory:** Service inventory is a management accounting concept that refers to how much service a business can provide in a given period. A hotel with 10 rooms, for example, has a service inventory of 70 one-night stays in each week.
10. **Transit Inventory:** Also known as pipeline inventory, transit inventory is stock that’s moving between the manufacturer, warehouses and distribution centers. Transit inventory may take weeks to move between facilities.
11. **Theoretical Inventory:** Also called book inventory, theoretical inventory is the least amount of stock a company needs to complete a process without waiting. Theoretical inventory is used mostly in production and the food industry. It’s measured using the actual versus theoretical formula.
12. **Excess Inventory:** Also known as obsolete inventory, excess inventory is unsold or unused goods or raw materials that a company doesn’t expect to use or sell but must still pay to store.

## Techniques of inventory control

### **A. Economic Order Quantity (EOQ)**

The optimal size of an order for replenishment of inventory is called economic order quantity. Economic order quantity (EOQ) or optimum order quantity is that size of the order where total inventory costs (ordering costs + carrying costs) are minimized. Economic order quantity can be calculated from any of the following two methods:

# Management Science

- ❖ Formula Method
- ❖ Graphic Method

- i. **Formula Method:** It is also known as ‘SQUARE ROOT FORMULA’ or ‘WILSON FORMULA’ as given below:

$$EOQ = \sqrt{\frac{2RO}{C}}$$

Where, EOQ = Economic Order Quantity

R = Annual Requirement or consumption in units

O = Ordering Cost per order

C = Carrying Cost per unit per year

- ii. **Graphic Method:** The economic order quantity can also be determined with the help of graph. Under this method, ordering costs, carrying costs and total inventory costs according to different lot sizes are plotted on the graph. The intersection point at which the inventory carrying cost and the ordering cost meet, is the economic order quantity. At this point the total cost line is at minimum.

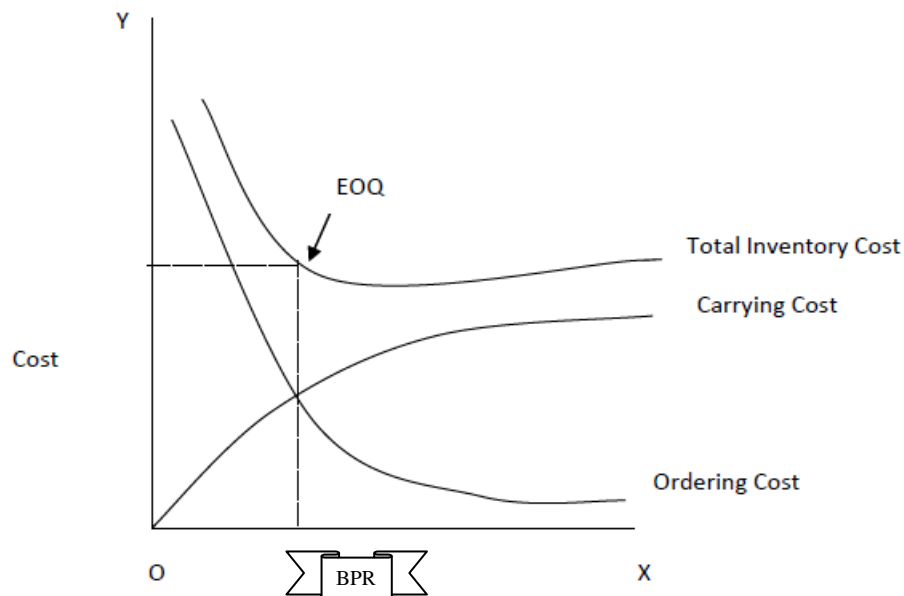

*Assumptions: The following assumptions are made:*

1. The rate of consumption of inventory is assumed to be constant.
2. Costs will not change over time.
3. Lead time is assumed to be known and constant.
4. Per order cost, carrying cost and unit price are constant.
5. Carrying or holding costs are proportionate to the value of stock held.
6. Ordering cost varies proportionately with the price.

## **B. ABC Analysis**

According to this approach to inventory control high value items are more closely controlled than low value items. Each item of inventory is given A, B or C denomination depending upon the amount spent for that particular item. “A” or the highest value items should be under the tight control and under responsibility of the most experienced personnel, while “C” or the lowest value may be under simple physical control.

It may also be clear with the help of the following examples: “A” Category – 5% to 10% of the items represent 70% to 75% of the money value. “B” Category – 15% to 20% of the items represent 15% to 20% of the money. “C” Category The remaining number of the items represent 5% to 10% of the money value. The relative position of these items show that items of category A should be under the maximum control, items of category B may not be given that much attention and item C may be under a loose control.

*Advantages of ABC Analysis*

1. It ensures a closer and a more strict control over such items, which are having a sizable investment in there.
2. It releases working capital, which would otherwise have been locked up for a more profitable channel of investment.
3. It reduces inventory-carrying cost.
4. It enables the relaxation of control for the ‘C’ items and thus makes it possible for a sufficient buffer stock to be created.
5. It enables the maintenance of high inventory turnover rate.

## PROCEDURES FOR PURCHASING MATERIALS

**1. Determining Purchase Budget:** Purchase Manager prepares a purchase budget for the forthcoming financial year. Purchase budget is prepared with the help of production planning department. It contains detailed information regarding quantity to be purchased, quality of materials, time of purchase and the sources of procurement.

**2. Receipt of Purchase Requisition:** The purchase officer initiates action for the purchase of materials. The store-keeper and departmental heads send requisition slips to purchase department giving details of materials required by their departments etc. A purchase requisition is a form used as a formal request to the purchasing department to purchase materials.

**3. Determining Sources of Supply:** Purchase Manager remains in touch with various suppliers of materials. The quotations are invited for the purchase of specific items. After receiving quotations a comparative study is made regarding terms and conditions offered. The factors to be considered include price, quantity, quality, time of delivery, terms of payment, trade discount and reputation of suppliers.

**4. Placing Order:** After selecting a supplier a formal purchase order is sent for the supply of goods. A purchase order is sent on a printed form and is duly authorized by the purchase manager. This order should contain details about the quantity, quality, price, mode of delivery, terms of payment etc. The purchase order authorizes the vendor to dispatch goods specified in it.

**5. Follow-Up of Purchase Order:** A purchase order normally bears a date by which the goods must be delivered. It is in the interest of the organization that goods are received in time for keeping uninterrupted flow of materials. The suppliers may be reminded of the date of delivery of goods. A follow-up of purchase order is necessary to receive stocks in time.

**6. Receipt and Inspection of Materials:** The task of receiving materials is assigned to the purchase department whereas in small concerns this work is done by the store keeper. After unpacking goods their quantity is compared to that given in delivery challans. Any discrepancy in items is reported to the purchase department. The specifications and quality of goods is also checked at this stage.



# Management Science

---

**7. Checking Invoices:** Lastly, purchase department checks the invoices supplied by the vendor with that of its own records. The quantity, quality, price, terms etc. are compared with those given in purchase order. After making full checking the invoices are sent to accounts department for payment.

## STORES MANAGEMENT

Store is an important component of material management since it is a place that keeps the materials in a way by which the materials are well accounted for, are maintained safe, and are available at the time of requirement. Literally store refers to the place where materials are kept under custody.

Typically a store has a few processes and a space for storage. The main processes (Fig 1) of store are (i) to receive the incoming materials (receiving), (ii) to keep the materials as long as they are required for use (keeping in custody), and (iii) to move them out of store for use (issuing).

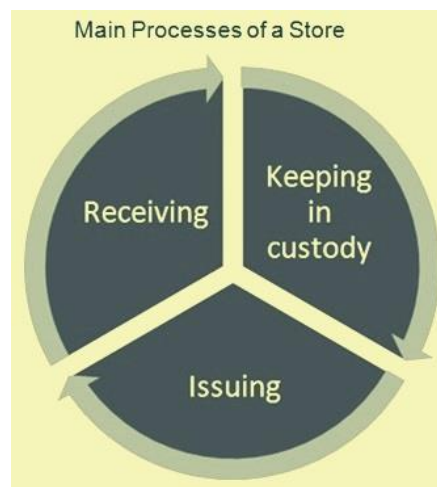

### **Objectives of store management:**

1. To ensure uninterrupted supply of materials without delay
2. To prevent overstocking and under stocking of the materials
3. To ensure safe handling of materials and prevent their damage.
4. To protect materials from pilferage, theft, fire and other risks
5. To minimize the cost of storage.

## Functions of a store

- Receipt of incoming materials
- Supervision of unloading of materials and tallying of materials
- Checking for damages or shortages and preparation of the report
- Filling of 'goods inward', 'day book', or 'daily collection' register
- Completion of vendors consignment note (challans)
- Preparation of 'goods receipt note' (GRN)
- Preparation of 'goods rejection memo' (in case of rejection of materials)
- Sending of materials to the respective stores
- Sending of the relevant documents to the respective departments
- Ensuring all storage and material handling facilities are in proper working order
- Ensuring good housekeeping and cleanliness in the storage space
- Checking, counting and tallying of materials before issue
- Making prompt entries in 'Bin card' or stock card
- Ensuring regular stock verification

## Classification of stores

- **Functional stores** – Functional stores are named based on the function of the materials stored. Examples are fuels store, chemicals store, tools store, raw materials store, spare parts store, equipment store, electric store, explosives store, and finished goods store etc.
- **Physical stores** – Physically stores can be centralized stores or decentralized stores. These stores are named based on the size and location of the store. Examples are central store, sub store, department store, site store, transit stores, receipt store, intermediate store, open yard store, and covered store etc.
- Stores are also *classified by naming* them after the departments to which they serve. Examples are construction stores, operation stores, rolling mill stores, blast furnace stores, and steel melting shop stores etc.
- Stores are sometimes *classified based on the nature of materials stored* in them. Examples are general store, bonded store, perishable store, and inflammable store, salvage store, reject store, and quarantine store etc.

# Management Science

---

## MARKETING MANAGEMENT

In today's world of marketing, everywhere you go you are being marketed to in one form or another. Marketing is with you each second of your walking life. From morning to night you are exposed to thousands of marketing messages every day. Marketing is something that affects you even though you may not necessarily be conscious of it.

### **Definition of Marketing**

**According to American Marketing Association** - *"Marketing is an organizational function and set of processes for creating, communicating and delivering value to customers and for managing relationships in a way that benefits both the organization and the stakeholder."*

**According to Kotler (2000)** - *"A societal process by which individuals and groups obtain what they need and want through creating, offering, and freely exchanging products and services of value with others."*

### **Nature of Marketing**

**1. Marketing is an Economic Function:** Marketing embraces all the business activities involved in getting goods and services, from the hands of producers into the hands of final consumers. The business steps through which goods progress on their way to final consumers is the concern of marketing.

**2. Marketing is a Legal Process by which Ownership Transfers:** In the process of marketing the ownership of goods transfers from seller to the purchaser or from producer to the end user.

**3. Marketing is a Managerial function:** The emphasis is on how the individual organization processes marketing and develops the strategic dimensions of marketing activities.

# Management Science

---

**4. Consumer-oriented:** A business exist to satisfy human needs, hence business must find out what the desire of customer (or consumer) and thereby produce goods & services as per the needs of the customer. Thus, only those goods should be produce that satisfy consumer needs and at a reasonable profit to the manufacturer (or producer).

**5. Goal oriented:** Marketing seeks to achieve benefits for both buyers and sellers by satisfying human needs. The ultimate goal of marketing is to generate profits through the satisfaction of the customer.

**6. Selection of Target Markets:** No marketer can satisfy everyone in the market. A marketer has to select target markets rather than a quixotic attempt to win every market and be all things to all people. Therefore, marketers start with market segmentation, choosing a target group(s), identifying target group needs and requirements and meeting these needs in a better way than the competitors through a suitable marketing mix.

## Objectives of Marketing

- **Customer Satisfaction:** The primary motive of a company is to satisfy the needs of customers.
- **Ensure Profitability:** Every business is run for profit, and so goes for marketing.
- **Building Organizational Goodwill:** It portrays the product and the company's positive image in front of the customers.
- **Create Demand:** It works for generating the demand for products and services among the customers.
- **Increase Sales Volume:** It is a rigorous process of increasing the sale of product or service to generate revenue.
- **Enhance Product Quality:** Marketing initiates customer feedback and reviews to implement them for product enhancement.
- **Create Time and Place Utility:** It makes sure that the product or service is available to the consumer whenever and wherever they need it.

# Management Science

---

## Functions of Marketing

- a. **Market Research:** A complete research on competitors, consumer expectations and demand is done before launching a product into the market.
- b. **Market Planning:** A proper plan is designed based on the target customers, market share to be captured and the level of production possible.
- c. **Product Design and Development:** Based on the research data, the product or service design is created.
- d. **Buying and Assembling:** Buying of raw material and assembling of parts is done to create a product or service.
- e. **Product Standardization:** The product is graded as per its quality and the quality of its raw materials.
- f. **Packaging and Labeling:** To make the product more attractive and self-informative, it is packed and labeled listing out the ingredients used, product use, manufacturing details, expiry date, etc.
- g. **Branding:** A fascinating brand name is given to the product to differentiate it from the other similar products in the market.
- h. **Pricing of the Product:** The product is priced moderately keeping in mind the value it creates for the customer and cost of production.
- i. **Promotion of the Product:** Next step is to make people aware of the product or service through advertisements.
- j. **Warehousing and Storage:** The goods are generally produced in bulks and therefore needs to be stored in warehouses before being sold in the market in small quantities.

# Management Science

---

- k. **Selling and Distribution:** To reach out to the consumers spread over a vast geographical area, selling and distribution channels are to be selected wisely.
- l. **Transportation:** Transportation means are decided for transfer of the goods from the manufacturing units to the wholesalers, retailers and consumers.
- m. **Customer Support Service:** The marketing team remain in contact with the customers even after selling the product or service to know the customer's experience, and the satisfaction derived.

## Core Concepts of Marketing

**1. Needs:** Existence of unmet needs is precondition to undertake marketing activities. Marketing tries to satisfy needs of consumers. Human needs are the state of felt deprivation of some basic satisfaction. Needs are physiological in nature. People require food, shelter, clothing, esteem, belonging, and likewise.

**2. Wants:** Wants are the options to satisfy a specific need. They are desire for specific satisfiers to meet specific need. For example, food is a need that can be satisfied by variety of ways, such as sweet, bread, rice, puff, etc. These options are known as wants.

**3. Demand:** Demand is the want for specific products that are backed by the ability and willingness (may be readiness) to buy them. It is always expressed in relation to time. All wants are not transmitted in demand. Such wants which are supported by ability and willingness to buy can turn as demand.

**4. Product:** Product can also be referred as a bundle of satisfaction, physical and psychological both. Product includes core product (basic contents or utility), product-related features (color, branding, packaging, labeling, varieties, etc.), and product-related services (after-sales services, guarantee and warrantee, free home delivery, free repairing, and so on).

**5. Utility (value), Cost, and Satisfaction:** *Utility* means overall capacity of product to satisfy need and want. It is a guiding concept to choose the product. Every product has varying degree of utility. As per level of utility, products can be ranked from the most

need-satisfying to the least need-satisfying. *Cost* means the price of product. It is an economic value of product. The charges a customer has to pay to avail certain services can be said as cost. *Satisfaction* means fulfillment of needs. Satisfaction is possible when buyer perceives that product has more value compared to the cost paid for. Satisfaction closely concerns with fulfillment of all the expectations of buyer.

**6. Exchange, Transaction, and Transfer:** *Exchange* is in the center of marketing. Marketing management tries to arrive at the desired exchange. Exchange is possible when following five conditions are satisfied:

- There should be at least two parties
- Each party has something that might be of value to the other party
- Each party is capable of communication and delivery
- Each party is free to accept or reject the exchange offer

It implies that people are negotiating and moving toward the agreement. When an agreement is reached, it is transaction. *Transaction* is the decision arrived or commitment made.

Transaction involves following conditions:

- At least two things of value
- Agreed upon conditions
- A time of agreement
- A place of agreement
- *A law (legal system) of contract to avoid distrust*

*Transfer* involves obtaining something without any offer or offering anything without any return. For example, Mr. X gives gift to Mr. Y. Transfer is a one-way process.

**7. Relationships and Network:** Marketing practice based on relation building can be said as **relationship marketing**. Relationship marketing is the practice of building long-term profitable or satisfying relations with key parties like customers, suppliers, distributors, and others in order to retain their long-term preference in business. *Network* is the ultimate outcome of relationship marketing. A marketing network consists of the company and its

# Management Science

---

supporting stakeholders – customers, employees, suppliers, distributors, advertising agencies, colleges and universities etc.

**8. Market, Marketing, Marketer, and Prospect:** A *market* consists of all potential customers sharing a particular need or want who might be willing and able to engage in exchange to satisfy this need or want. *Marketing* is social and managerial process by which individuals and groups obtain what they need and want through creating and exchanging product and value with others.

*Marketer* is one who seeks one or more prospects (buyers) to engage in an exchange. Here, seller can be marketer as he wants other to engage in an exchange. Normally, company or business unit can be said as marketer. *Prospect* is consumer or customer who buys product from a company for satisfying his needs or wants can be said as the prospect.

## MARKETING PHILOSOPHIES

**1. The Production Concept:** The production concept is the oldest concept in business. The production concept holds that consumers will prefer products that are widely available and inexpensive.

**Ex:** Managers of production-oriented business concentrate on achieving high production efficiency, low costs and mass distribution. They assume that consumers are primarily interested in product availability and low prices. This orientation makes sense in developing countries, where consumers are more interested in obtaining the product than its features. It is also used when a company wants to expand the market.

**2. The Product Concept:** The product concept holds that consumers will favor those products that offer the most quality, performance, or innovative features.

**Ex.** Managers in these organizations focus on making superior products and improving them over time. They assume that buyers admire well-made products and can appraise quality and performance.



# Management Science

---

**3. The Selling Concept:** The selling concept is another common business orientation. The selling concept holds that consumers and businesses, if left alone, will ordinarily not buy enough of the organizations products. The organization must, therefore, undertake an aggressive selling and promotion effort. It also assumes that the company has a whole battery of effective selling and promotion tools to stimulate more buying.

**4. The Marketing Concept:** The marketing concept holds that the key to achieving its organizational goals consists of the company being more effective than competitors in creating, delivering, and communicating customer values to its chosen target markets. The marketing concept rests on four pillars: target market, customer needs, integrated marketing and profitability.

**5. Societal Marketing Concept:** The societal marketing concept calls upon marketers to balance three considerations in setting their marketing policies, viz. company profits, consumer satisfaction, public interest. Societal Marketing concept focuses on: Less Toxic Products More Durable Products, Products with Reusable or Recyclable Material.

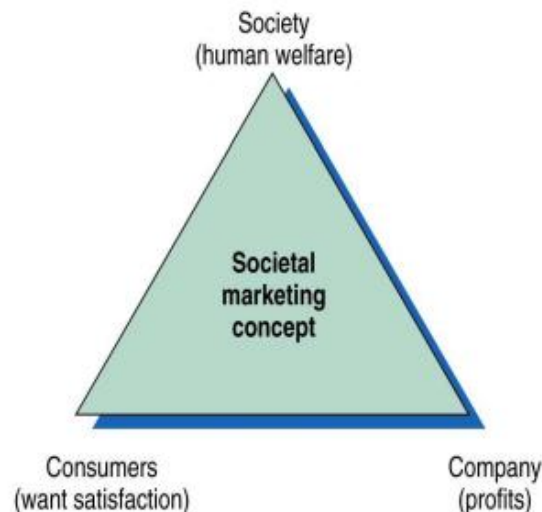

## MARKETING MIX

The marketers deliver value to the customer basically through his market offer. He takes care to see that the offer fulfils the needs of the customer. He also ensures that the customer perceives the terms and conditions of the offer as more attractive vice-versa other competing

# Management Science

---

offers. Marketing Mix is the set of marketing tools that the firm uses to pursue its marketing objectives in the target market. It is the sole vehicle for creating and delivering customer value.

Definition:

*According to Mc McCarthy: "A set of tools used to pursue marketing objectives in Target market"*

*McCarthy* has provided an easy to remember description of the marketing mix variables. Over the years, the terms-Marketing mix and four Ps of marketing-have come to be used synonymously.

- 1. Product:** The most basic marketing mix tool is product, which stands for the firm's tangible offer to the market including the product quality, design, variety features, branding, packaging, services, warranties etc.



- 2. Price:** A critical marketing mix tool is price, namely, the amount of money that customers have to pay for the product. It includes deciding on wholesale and retail prices, discounts, allowances, and credit terms. Price should be commensurate with

# Management Science

---

the perceived value of the offer, or else buyer will turn to competitors in choosing their products.

- 3. Promotion:** The fourth marketing mix tool, stands for the various activities the company undertakes to communicate its products' merits and to persuade target customers to buy them. It includes deciding on hire, train, and motivates salespeople to promote its products to middlemen and other buyers. It also includes setting up communication and promotion programs consisting of advertising, personal selling, sales promotion, and public relations.
- 4. Place:** This marketing mix tool refers to distribution. It stands for various activities the company undertakes to make the product easily available and accessible to target customers. It includes deciding on identify, recruit, and link various middlemen and marketing facilitators so that products are efficiently supplied to the target market.

## Advertising Management

The term advertising originates from the Latin word '*Adverto*' which means *to turn around*. Advertising has been defined as “*any paid form of non personal presentation & promotion of ideas, goods or services by an identified sponsor.*” Ads can be a cost effective way to disseminate messages. The mere transmission of an advertising message does not imply that the advertiser has communicated with the audience. His audience must see the advertisement & must pay attention to it.

### Features of Advertising

- 1. Provides information:** Advertising's primary purpose is to provide information about products or services to prospective buyers. The details of products such as features, uses, prices, benefits, manufacturer's name, so on; are in the advertisements. The key message

# Management Science

---

and brand name are also there. The information supplied educate and guide consumers and facilitate them to make a correct choice while buying a product.

2. **Paid communication:** Advertising is a form of paid communication. The advertiser pays to the media for giving publicity to his AD message. He also decides the size, slogan, etc. given in the advertisement.

3. **Non-personal presentation:** Advertising is non-personal in character as against salesmanship, which is a personal or face to face communication. Here, the message is given to all and not to one specific individual. This rule is applicable to all media including the press. However, even in it, target consumers or target market can be selected for making an AD appeal.

4. **Publicity:** Advertising publicizes goods, services, ideas and event events. It is primarily for giving information to consumers. This information is related to the features and benefits of goods and services of different types. It offers new ideas to customers as its contents are meaningful. The aim is to make the popularize ideas and thereby promote sales. For example, an advertisement for family planning, family welfare, and life insurance is useful for placing new ideas before the people.

5. **Primarily for Persuasion:** Advertising aims at the persuasion of potential customers. It attracts attention towards a particular product, creates a desire to have it, and finally induces consumers to visit the market and purchase the same. It has a psychological impact on consumers. It influences their buying decisions.

**Advantages of Advertising:** The advertising benefits two main groups, namely:

1. Manufacturers, and
2. Consumers.

*A. The advantages of advertising for manufacturers:*

1. **Large-scale production and marketing:** Advertising is useful as a sales promotion technique. It gives information to consumers and encourages them to purchase more.

Manufacturers expand their production base due to a higher market demand created through advertisements.

**2. Introducing new products:** Advertising facilitates the introduction of new products. Due to it, information about new products is given to the people (prospects). A demand generates because of this, and the manufacturer can sell new products along with the existing ones.

**3. Creates new demand:** Advertising spreads information and encourages consumers to purchase new products. It creates a new demand. Customers are offered various concessions in the initial period. It generates positive responses from them, and soon new customers also respond. Thus, advertisement creates new demand from nonusers.

**4. Effective personal selling:** Advertising creates a proper background for personal selling. It gives advance information to the prospects. They visit the shop in order to purchase a particular product that they know through advertisements in media. The job of a salesman becomes easy as consumers develop an affinity for advertised products. In brief, it supports and supplements personal selling.

**5. Builds brand image:** Advertising build brand image and this develops consumer loyalty towards a specific brand. Manufacturers introduce branding to popularize their products with a distinct personality. Brands get popular through advertisements. As a result, buyers develop loyalty towards a specific brand.

### ***B. The benefits of advertising for consumers:***

**1. Information and guide:** Consumers get information and guidance from advertising. They can study the advertisements of competitors and select the appropriate products that are best suited and profitable to them. It helps to avoid their cheating and exploitation at the hands of middlemen.

# Management Science

---

2. **Acts as a reminder:** Advertising act as a reminder to consumers and alerts them about the urgent product they need to purchase.

3. **Attracts customers:** Advertising leads to competition among manufacturers and retailers. They have to offer something special in order to attract buyers. Such attraction offers benefits to consumers. For example, manufacturers have to bring down the price in order to attract customers. They have to supply quality goods in order to attract them more. All this is beneficial to consumers in terms of price and quality of goods.

4. **Raises living standards:** Advertising raises the standard of living of people by supplying information about goods and services, which can offer convenience and pleasure to them. It guides consumers in the selection of most suitable products for their daily life. Thus, it provides a higher standard of living to consumers as a social group.

5. **Efficient product use:** Consumers get information about uses or benefits of different products through advertising. They also get guidance as regards the right manner of using the product and help to avoid any possible damage from the use of a purchased product. The information supplied through advertisements helps to know how to use a product in different ways.

## **5M's of Advertising:**

Every organization or marketing communication firm handles their advertising in different ways. In small firms, advertising is handled by executives or account managers in the sales or marketing department, who works with an advertising agency. Large company often set up its own advertising department or hires an advertising agency to prepare their advertising programs.

In developing an advertising program, the marketing managers always start by identifying the target market and the buyer's intentions. Then they make the five major decisions in developing an advertising program, called the 5 M's of Advertising, viz.

1. **Mission:** Advertising Objectives can be classified as to whether their aim is:

# Management Science

---

- **To inform:** This aim of Advertising is generally true during the pioneering stage of a product category, where the objective is building a primary demand. This may include :
  - Telling the market about a new product
  - Suggesting new uses for a product
  - Informing the market for a price change
  - Informing how the product works
  - Building a company image
- **To persuade:** Most advertisements are made with the aim of persuasion. Such advertisements aim at building a selective brand.
- **To remind:** Such advertisements are highly effective in the maturity stage of the product. The aim is to keep the consumer thinking about the product.

**2. Money:** Deals with deciding on the Advertising Budget. The advertising budgets classified into following:

- Percentage of sales method.
- Affordable method.
- Competitive parity method.
- Objective and task method.

**3. Message:** The various stages of preparing advertising message are:

- Message generation
- Message evaluation and selection
- Message rating
- Message execution

**4. Media:** Media is the medium through which advertising conveys. When choosing how to convey an advertisement, members of the department focus on the *reach, impact and frequency* of the media while considering the advertisement itself.

**5. Measurement:** Measurement is a post advertisement set of activities that measures how effective an advertisement was to the target audience and for the product. This step helps increase overall profitability of an advertisement and can help improve advertisements in the future.

### SALES PROMOTION

**A. Sales promotion tools for consumers (Consumer promotion tools):** The marketers need to choose the right sales promotion tool to reach its audience. Below are the major promotion tools directed towards consumer -

1. **Free samples** – The manufacturer offers free samples to consumers in various ways doing door-to-door visits, at retail stores, malls, attached to another product, etc. For example, attaching a sample of a shampoo sachet with a bottle of a beauty lotion. The purpose is to gain new customers or enter into a new market.
2. **Exchanges** – Customer are asked to submit the old product and a new product is offered at a new price. The organizations sometimes asks to submit the old product manufactured by them, but sometimes, the exchange rolls over to a product from any brand.
3. **Sales promotion letters** – Sent to buyer's homes and offices giving information on promotion activity or information on the products.
4. **Coupons** – These are certificates by which a buyer can buy a product at a reduced price. These are mailed, accompanied with other products, with newspapers or magazines, or even direct mail.
5. **Demonstrations** – Demonstrations are done at retail stores and malls. For example, sales people at malls and retail stores demonstrate perfumes, cosmetic products, small electronic items, etc. Company's also doing door-to-door demonstrations as not all the people visit stores regularly.
6. **Gifts or Premium** – Products are offered free or at a low cost for buying a particular product. For example, buy one get one free, book a flat with no EMI for first year, etc. The



# Management Science

---

company also gives out gifts like wallets, calendars, diaries, etc. along with a purchase. These gifts carry the company's logo and name.

**B. Sales promotion tools for middlemen/ dealers (Trade promotion tools)** –The manufacturers need co-operation of the middlemen for sale of its products. It is important for the manufacturer that the middlemen are encouraged to drive sales of the products. Below are the major trade promotion tools-

1) **Attractive terms of sale** – take back offers, business on credit facility, price discount or allowance like free or extra units of the product to encourage the store manager to run the brand's promotions.

2) **Dealer contests** – Dealers with maximum sales or window display are rewarded.

3) **Services to dealers** – Manufacturers help in designing and arrangement of the goods in the store. Training and sale techniques coaching given to the dealers staff free of charge.

**C. Sales force promotion tools:** These are directed towards the company's sales force so that they put in extra effort in making sales.

1) **Manufacturers organize sales contests** wherein the winners are rewarded by way of money, incentives, trips, gifts, etc.

2) **Trade shows** – Trade shows or conventions are organised to meet new customers, introduce new products, educating customers about the new as well as existing products. These help the manufacturers come in direct contact with the buyers. Manufacturers sign contracts worth millions or even billions in international trade shows.

## MARKETING CHANNELS

A marketing channel performs the work of moving goods from producers to consumers. It over comes the time, place and possession gaps that separate goods and services from those who would use them. The goal of marketing is the matching of segments of supply and demand. Most of the products are not sold directly to the customers by the firms.

# Management Science

---

Between the company and the final user there are different market intermediaries performing a variety of functions and bearing a variety of names. Wholesalers, retailers, agents, and distributors are some of them. Each channel member generates a different level of sales and costs. Marketing channel decisions are very important decisions and influence all other marketing decisions.

## Types of Distribution Channels:

### A. Consumer Channels

- 1. Direct Channel or Zero Level Channels:** When the producer or the manufacturer directly sells the goods to the customers without involving any middlemen, it is known as direct channel or zero level channels. It is the simplest and the shortest mode of distribution. Selling through post, internet or door to door selling etc. are the examples of this channel. For example, Mc Donald's, Bata, Mail order etc.
- 2. Indirect Channels:** When a manufacturer or a producer employs one or more middlemen to distribute goods, it is known as indirect channel. Following are the main forms of indirect channels:
  - (a) Manufacturer-Retailer-Consumer (One Level Channel):** This channel involves the use of one middleman i.e. retailer who in turn sells them to the ultimate customers. It is usually adopted for specialty goods. For example Tata sells its cars through company approved retailers.

*Manufacturer → Retailer → Consumer*

- (b) Manufacturer-Wholesaler-Retailer-Customer (Two level channels):** Under this channel, wholesaler and retailer act as a link between the manufacturer and the customer. This is the most commonly used channel for distributing goods like soap, rice, wheat, clothes etc.

*Manufacturer → Wholesaler → Retailer → Customer*

- (c) Manufacturer-Agent-Wholesaler-Retailer-Consumer (Three level channels):** This level comprises of three middlemen i.e. agent, wholesaler and the retailer. The manufacturers supply the goods to their agents who in turn supply

# Management Science

---

them to wholesalers and retailers. This level is usually used when a manufacturer deal in limited products and yet wants to cover a wide market.

*Manufacturer → Agent → Wholesaler → Retailer → Consumer*

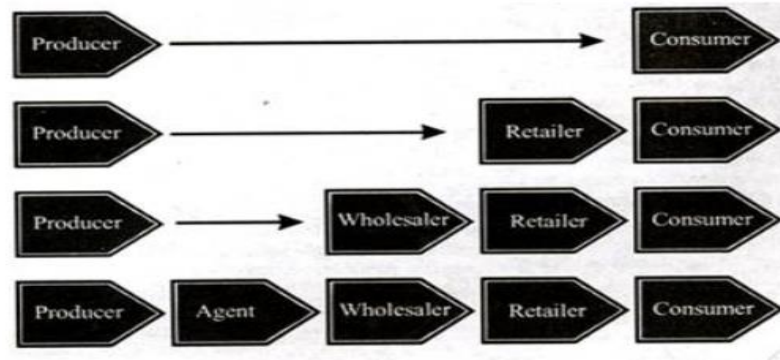

## B. Industrial channels:

Industrial channels are usually shorter than consumer channels. Direct selling is prevalent due to closer relationship between the manufacturer and the customer, as well as due to the nature of the product sold.

**1. Manufacturer to industrial customers:** This is a common channel for expensive industrial products like heavy equipments and machines. There needs to be close relationship between the manufacturer and the customer, because the product affects the operations of the buyer.

The seller has to participate in many activities like installation, commissioning, quality control and maintenance jointly with the buyer. The seller is responsible for many aspects of the operations of the product long after the product is sold. The nature of the product requires a continuing relationship between the seller and the buyer. The large size of the order makes direct selling and distribution economical.

**2. Manufacturer to agent to industrial customer:** A company that sells industrial products can employ the services of an agent who may sell a range of products from several producers on a commission basis. Such an arrangement spreads selling costs and is

beneficial to companies who do not have the resources to set up their own sales and distribution operation.

The arrangement allows the seller to reach a large number of customers without having to invest in a sales team. But the company does not have much control over the agent, who does not devote the same amount of time and attention as a company's dedicated sales team.

**3. Manufacturer to distributor to industrial customer:** For less expensive, more frequently purchased products, distributors are used. The company has both internal and field sales staff. Internal staff deals with customer and distributor generated enquiries and order placing, order follow-up and checking inventory levels. Outside sales staff is proactive.

They find new customers, get product specifications, distribute catalogues and gather market information. They also visit distributors to address their problems and keep them motivated to sell the company's products. Distributors enable customers to buy small quantities locally.

**4. Manufacturer to agent to distributor to industrial customers:** The manufacturer employs an agent rather than a dedicated sales force to serve distributors mainly because it

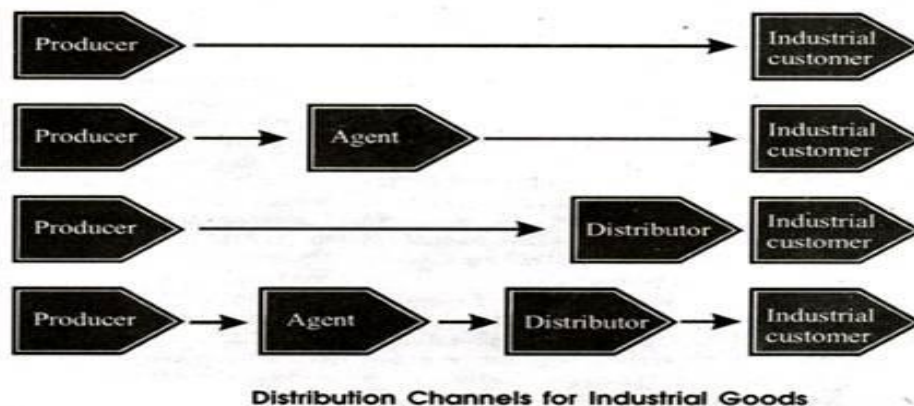

is less expensive to do so. The agent may sell the goods of several suppliers to an industrial distributor, who further sells it to the business user. This type of channel may be required when business customers require goods rapidly, and when an industrial distributor can provide storage facilities.

## C. Service channels:

Distribution channel for services are usually short, and are either direct or use an agent. Since stocks are not held, the role of wholesalers, retailers or industrial distributors does not apply.

**1. Service provider to consumer or industrial customer:** Close relationship between service provider and customer means that service supply has to be direct, for instance, healthcare.

The service provider operates several outlets to reach out to the final consumer or to the industrial buyer. Many service providers such as banks, retail outlets, service centers operate via this distribution channel.

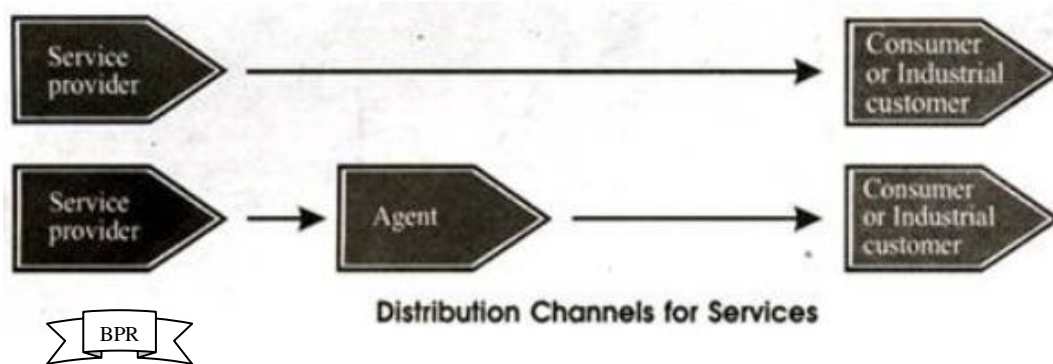

**2. Service provider to agent to consumer or industrial customer:** Agents are used when the service provider is geographically away from customers and when it is not economical for the provider to establish its own local sales team.

For instance, many financial institutions are using this distribution channel to cross sell their services to customers by using a database of existing or potential customers.

## PRODUCT LIFE CYCLE

A product passes through certain distinct stages during its life, and this is called the *product life cycle (PLC)*. The (PLC) concept is used to understand the market behavior at different stages of life cycle and to apply different marketing strategies to get better results.

---

# Management Science

---

The PLC is normally presented as a sales curve representing the product's journey from introduction to exit as shown in figure 7.3 most product life cycle curves are portrayed as bell shaped. This curve is typically divided into four stages; *introduction, growth, maturity, and decline.*

1. **Introduction;** A period of slow sales growth as the product is introduced in the market. Profits are nonexistent because of the heavy expenses incurred with product introduction

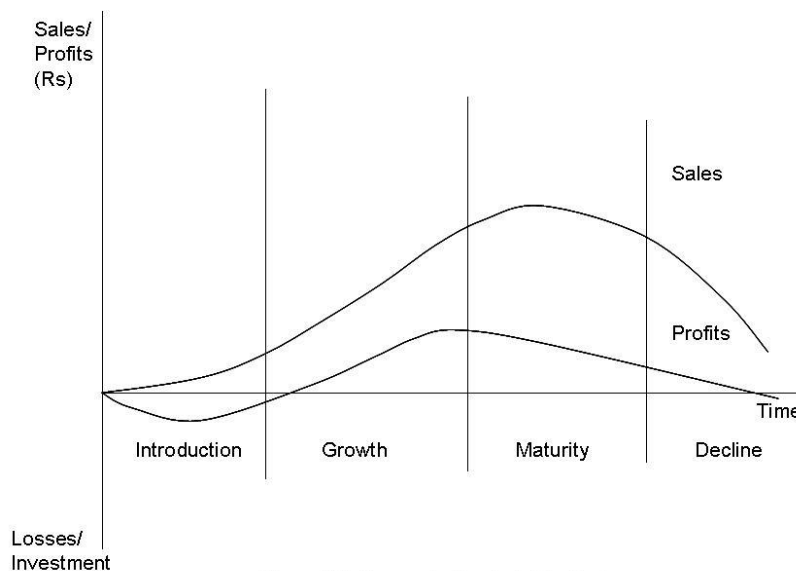

Figure 7.3 Stages in Product Life Cycle

## Strategies in the introductory state:

- **Rapid skimming strategy:** Introducing the product at a high price and a high promotion levels. The firm charges a high price in order to recover as much gross profit per unit as possible. Affirm spends large amounts on promotion to convince the market event the high price. This high spending on promotion speeds up the rate of; market penetration.
- **Slow skimming strategy:** Introducing the product at high price and low promotion. The high price makes firm to realize high gorse profit per until, and low level of promotion keeps firms marketing expenditure down. When the merest size and potential competition is low, this particular strategy words.

# Management Science

---

- **Rapid penetration strategy:** Launching the product at low price spending high amount on promotion. This strategy brings us fastest market share and market penetration. This strategy is suitable for large markets particularly when buyer surprise sensitive, when there is a strong potential competition, and the market is unaware of the product.
- **Slow penetration strategy:** Launching a product at low price and low level of promotion. Low price may encourage high product acceptance, and low level of promotion helps firms to realize more not profit. This approach is suitable for large markets, price sensitive and with some potential competition.

The pioneer, who introduces the product in the market, must choose a launch strategy that is consistent with its intended product positioning. This is the first step in a grand plan of life cycle marketing.

		Promotion	
		High	Low
Price	High	Rapid Skimming Strategy	Slow Skimming Strategy
	Low	Rapid Penetration Strategy	Slow Penetration Strategy

Figure 8.1 Introductory Marketing Strategies

2. **Growth:** A period of rapid market acceptance and substantial profit improvement  
**Strategies in the growth stage:** Following steps are going to help the firm to sustain market growth as long as possible.
  1. **Improve product quality:** Companies has to focus on improving product quality to sustain in the market.

2. **Adding new product features;** New features for the existing products should be added to make the product more appealing and contemporary to attract and retain customers.
  3. **Adding new models:** New models must be added continuously to make the existing product portfolio look attractive. This will make company to occupy more shelf space at retailer's outlet.
  4. **Entering new market segments:** As the product fared well in one particular market segment, to sustain its growth, companies have to enter into new markets.
  5. **Decreasing price to attract low segment:** The price of the product is to be decreased to attract lower class segment. In this segment majority of the customers are price sensitive. This helps the company; to enter into new markets.
  6. **Distribution channels:** Company has to increase distribution coverage and look for new distribution channels to make the product easily available to its target customers.
- 3. Maturity:** A period of slowdown in a sales growth because the product has achieved acceptance by most potential buyers. Profits stabilize or decline because of increased competition.

**Strategies in the maturity stage:**

- 1) **Market modification:** The Company has to increase sales volume for their matured brands by expanding the number of brand users as well as usage rate is ser. The company has to convert nonuser into user, enter new market segments, and winning competitor's customers. Making the current customers to increase their annual usage of the brand can also increase sales. The company can try to make customers to use the product more frequently, more usage per occasion, and identify the new uses for the product and convince the customer to use the product in more varied ways.



- 2) **Product modifications:** By modifying the product's characteristics marketers try to increase the sales. Improving product quality aims at increasing the functional performance of the product like its durability, reliability, and taste, this makes buyers to accept the new and improved version of the product and they might be ready to pay more prices for it. Feature improvement of the product for example, size, weight and other accessories also make products more attractive. Style improvement of the product makes it more aesthetic and novel.
  - 3) **Marketing mix modification:** Product managers might also try to stimulate sales by changing one or more marketing mix elements. Change in the composition of the marketing mix may help company to reach the target customers. However, these changes are easily imitated by the competitors. For instance, if a company decreases the price of the product, the competitors may also propose for price decrease. This leads to price war among the companies and none of them will get any benefit out of this situation.
- 4. Decline:** The period when sales show a downward drift and profits erode.

**Strategies during decline stage:**

- 1) **Identifying the weak products;** The company has to identify the weak products and if possible the company should try to modify them if not discontinue them. Appointing product review committee with representatives from marketing, R&D, manufacturing, and finance. This committee has to identify weak products with the help of data regarding market size, market share, prices, costs and profits. The review committee examines this information and makes recommendation for each doubtful product whether to continue it, change marketing strategy, or drop it.
- 2) **Determining marketing strategies:** In declining markets some firms withdraw their products earlier than other. There are some exit barriers which make the product withdrawal a little difficult. If there are few exit barriers, it is easy for the firms to leave the market. The remaining firms in the market try to attract the

customers of the withdrawing firms. Harrigan distinguished five decline strategies available to firm;

- Increasing the firm's investment to strengthen its competitive position.
- Maintaining the firm's investment level until the uncertainties about the industry are resolved.
- Decreasing the firm's investment level selectively.
- Harvesting firm's investment to recover cash quickly, and
- Diverting the business quickly by disposing of its assets as advantageously as possible.

- 3) **Product withdrawal;** When a company decides to drop a product, it has to take several other decisions. If the product has residual goodwill and strong distribution, the company can sell it to a smaller firm. If the company can't find buyers, it must decide whether to liquidate the brand slowly or quickly. It also should take a decision how to service the past customers, how much stock of spare parts to be maintained to support the past customers.

## UNIT – III – HUMAN RESOURCE MANAGEMENT

HRM is concerned with the human beings in an organization. “The management of man.” It is a very important and challenging job because of the dynamic nature of the employees. As no two people are similar in nature in every aspect of mental abilities, tacticians, sentiments and behaviors they differ widely not only individually but also as a group.

### **Definition:**

*According to Flipppo: “Human Resource /Personnel Management may be defined as the planning, organizing, directing, and controlling of the procurement, development, compensation, integration and maintenance and separation of human resources to the end that individual, organizational and societal objectives are accomplished”*

### **Nature:**

1. HRM is based on certain principles and policies which helps the organization to achieve its objectives.
2. HRM is a pervasive function – It suggest that HRM is not associated to a single department, instead it is a broader function and is spread throughout the organisation, which manages all type of employees/people from lower level to top level departments of the organisation.
3. HRM is people oriented – The main core or concern for HRM is the People or human resource. Human resource management works with and for people. It acts as a bridge which brings people and organisation together to achieve individual and organisational goals.
4. HRM is continuous activity: As HRM needs to continuously train, develop, or replace to meet the growing level of competition and changes in the market. Hence, it is a continuous activity.

# Management Science

---

5. The HRM is a part of management function. Issues like hiring, training, development, compensation; motivation, communication, and administration etc of employees are taken care by Human resource management.

6. The main aim of HRM is optimum utilization of employees.

## Managerial and Operative functions

**1. Managerial Functions:** It includes Planning, Organising, Staffing, Directing and controlling (POSDC)

- A. **Planning:** Planning is to plan for future or predetermine the course of actions to be taken in future. It is a process of identifying the organisational goals and formulation of policies and programmes for achieving those goals.
- B. **Organising:** Organising is a process by which the structure and allocation of jobs are determined. Thus organizing involves giving each employee a specific task establishing departments, delegating authority to subordinates, establishing channels of authority and communication, coordinating the work of subordinates, and so on.
- C. **Staffing:** This is a process by which managers select, train, promote and remove their employees This involves deciding what type of people should be hired, recruiting, selecting employees, setting the performance standard, compensation of employees, evaluation of performance of employees, counseling employees, training and developing employees.
- D. **Directing/Leading:** Directing is the process of initiating or activating group efforts to achieve the desired organizational goals, which includes activities like getting subordinates to get the job done, maintaining their morale, motivating subordinates etc, for achieving the organizational goals.
- E. **Controlling:** It is the process of setting the standards for performance, measuring the actual performance of the employees and then comparing the actual performance with the standards and there by taking corrective actions as needed.

## Management Science

---

**2. Operative Functions:** The Management functions as suggested were common to all the managers whereas the Operative, also called as service functions are relevant to specific department only.

- A. **Procurement:** It involves procuring the right kind of people in the right or rather appropriate number to be placed in the organisation. It consists of activities such as manpower planning, recruitment, selection placement and induction or orientation of new employees.
  
- B. **Development:** It includes activities meant to improve the knowledge, skills aptitudes and values of employees so as to enable them to perform their jobs in a better manner in future. It comprises of training to employees, executive training to develop managers, organisation development to strike a better fit between organisational climate/culture and employees.
  
- C. **Compensation:** Compensation function involves determination of wages and salaries which should match with the contribution made by employees towards achieving organisational goals. In other words, this function ensures equitable and fair remuneration for employees in the organisation. It consists of activities such as job evaluation, wage and salary administration, bonus, incentives, etc.
  
- D. **Maintenance:** It is concerned with retaining or protecting and promoting employees while at work. For this purpose several benefits such as housing, medical, educational, transport facilities, etc. are provided to the employees. Several other social security measures such as provident fund, pension, gratuity, group insurance, etc. are also being given to the employees.

### EVOLUTION of HRM

The history of development of HR management in India is not very old rather it is of recent origin. Though if we search ancient era, there are facts available that Kautilya had dealt with some of the important aspects of Human Resources Management in his “Arthashastra”, written in 400 B.C. Rulers of those days adapted the techniques of HRM as suggested by Kautilya. In its modern

## Management Science

---

sense, it has developed and gained popularity only since independence. Though the importance of labour officers was recognized as early as 1929, Royal Commission Report on labour in India, which recommended the appointment of labour officers to solve labour and welfare problems, gained momentum only after the enactment of the Factories Act of 1948.

Section 49 of the Act directed the appointment of Welfare Officers in the companies having more than 500 workers. In the beginning; Government was concerned only with limited aspects of labour welfare. The earliest labour legislation in India dealt with certain aspects of Indian laborers (Regulation of Recruitment, Forwarding and Employment) sent to various British colonies in 1830.

### **Recent Developments:**

Recent developments in the area of human resources management include treating the employees as economic, social, psychological and spiritual men and women. The important aspects of development of human resources management year wise is shown below:

- From the year 1995, emphasis has been shifted to human resources development (HRD).
- In the year 1998, emphasis on HRD, cultural diversity, teamwork and participative management has been continuing. Further, the emerging areas are total quality in management in HRM, empowering the employees and developing empowered teams and integrating HRM with strategic management as the top management, realized that HRM is the core of competencies of the 21st century corporations. In the year 1999, second National Commission on Labour was setup to study the labour conditions.
- In the year 2001, emphasis has been on 'smart sizing of the organizations. In the year 2002, emphasis has been shifted to positive attitude of the candidate/employee rather than skill and knowledge.
- In the year 2003, shift from intelligence quotient (IQ) to emotional quotient (EQ).
- In the year 2004, shift from skilled workers to knowledge workers.
- In the year 2005, shift from hierarchical structure to flexible and virtual structures. In the year 2006, HRM has become the core of strategic management level.

# Management Science

---

- In the year 2007, the concept of HRM has been relegated to human capital management.
- In the year 2008, emphasis has been on retention management and development of own human resources by companies through alliances with universities/colleges. In the same year, there was decline in business operations due to global economic recession and crisis.
- In the year 2009, continuation of job cuts, pay costs and lay-offs due to prolonged global recession and crisis.
- In the year 2014, emphasis is shifted to talent management and flexible human resource policies and practices.

## Evolution of HRM ...

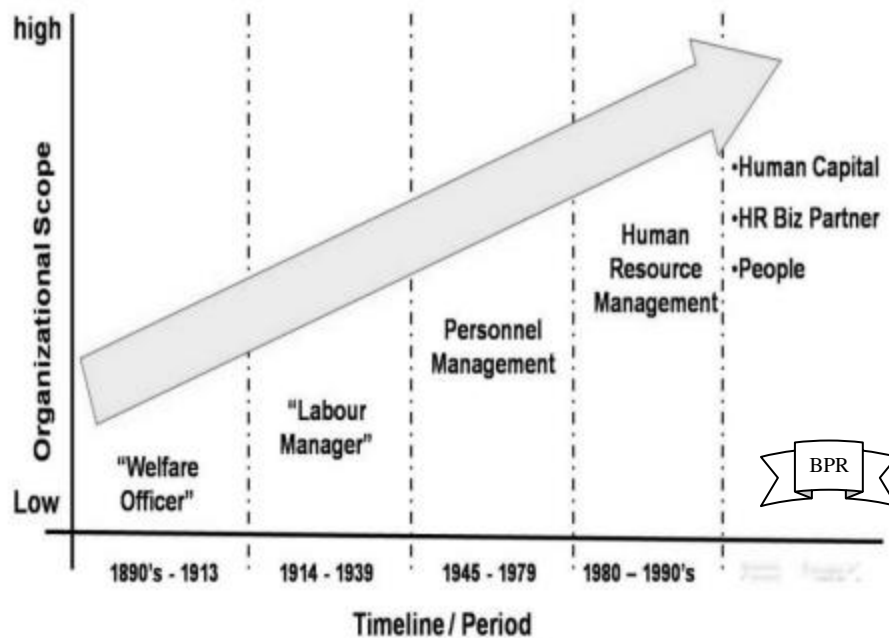

## JOB ANALYSIS

It is the process of identifying and choosing elaborated contents of a particular job, thus clearly defining duties, rules, responsibilities, accountabilities, and skills related to the job. Job analysis is the process of analyzing the job — what is the demand and requirement for the job, *and not of the individual*.

# Management Science

---

The process of job analysis gives two sets of data –

- **Job description** – Job description is a written statement including complete information about what all a job holds, like job title, duties, tasks and responsibilities related to job, working conditions and hazards, reporting relationships, tools, machines and equipment to be used, and relationships with other designations.
- **Job specification** – Job specification includes particulars regarding the capabilities that an individual should possess to perform the assigned tasks efficiently. This includes educational qualification, experience, training, appropriate skills, knowledge, and abilities required to perform the job.

## JOB EVALUATION

In contrast to job specification, job evaluation specifies the relative value or worth of each job in a company by examining the task and ranking the jobs accordingly.

Job evaluation can be done by any of the following methods –

- **Points rating** – Different levels are allotted to the various elements of jobs and then the points allocated to different levels are summarized to get the point score of the jobs. It forms the basis of pay structure.
- **Factor comparison** – A comparison of different independent factors of jobs is done and points are given to each factor scale of individual job. These points are then aggregated to rank the jobs.
- **Job ranking** – A job is not broken into factors or elements; instead, it is evaluated as a complete process and is compared with other jobs. After proper evaluation, jobs are scaled accordingly.
- **Paired comparison** – Jobs are compared with each other and points are allocated depending on being ‘higher, lesser or equal’. These points are added to prioritize the order of jobs. The jobs with higher priorities are given more attention as compared to others.



# Management Science

---

## MAN POWER PLANNING

Manpower Planning also called as Human Resource Planning suggest of putting right number of people, right kind of people at the right place, at right time, and doing the right things for which they are selected and suited for the achievement of goals of the organization. Human Resource Planning has got an important place in the arena of industrialization.

According to Geisler: *“Manpower planning or HR Planning is the process which includes forecasting, developing and controlling by which a organization ensures that it has the right number of people the right kind of people, at the right places, at the right time, doing work for which they are economically most usefull.”*

### **Need of Manpower Planning**

1. Shortages and surplus of employees can be identified so that quick action can be taken wherever required.
2. Manpower Planning becomes the base for all the recruitment and selection programmes..
3. It helps to reduce the labour cost by keeping a check on excess staff in the firm thereby controlling overstaffing.
4. It also helps to identify the available talents in a firm so that training programmes can be framed as accordingly to develop those talents.
5. It helps in growth and diversification of business. Through manpower planning, human resources can be readily available and they can be utilized in best manner.
6. It helps the organization to understand the importance of manpower management which finally helps in the stability of a concern.

## Objectives of Manpower Planning

1. To determine present requirement level of human resource so as to ensure smooth functioning of the organisation.
2. To analyze and calculate future skills requirement,
3. To provide control measures so as to ensure that necessary resources are available as and when required.
4. To anticipate redundancies and avoid unnecessary dismissals and assess training and development needs.
5. It is also needed for identifying surplus or shortage manpower areas and there by balancing manpower.

## Process of HRP

**1. Analyzing the current manpower inventory:** Before a manager makes forecast of future manpower, the current manpower status has to be analyzed. For this the following things have to be noted-

- Type of organization
- Number of departments
- Number and quantity of such departments
- Employees in these work units

**2. Making future manpower forecasts:** Once the factors affecting the future manpower forecasts are known, planning can be done for the future manpower requirements in several work units. The Manpower forecasting techniques commonly employed by the organizations are as follows:

- **Expert Forecasts:** This includes informal decisions, formal expert surveys and Delphi technique.
- **Trend Analysis:** Manpower needs can be projected through extrapolation (projecting past trends), indexation (using base year as basis), and statistical analysis (central tendency measure).

# Management Science

---

- **Work Load Analysis:** It is dependent upon the nature of work load in a department, in a branch or in a division
- **Work Force Analysis:** Whenever production and time period has to be analyzed, due allowances have to be made for getting net manpower requirements.
- **Other methods:** Several Mathematical models, with the aid of computers are used to forecast manpower needs, like budget and planning analysis, regression, new venture analysis.

**3. Developing employment programmes:** Once the current inventory is compared with future forecasts, the employment programmes can be framed and developed accordingly, which will include recruitment, selection procedures and placement plans.

**4. Design training programmes:** These will be based upon extent of diversification, expansion plans, development programmes etc. Training programmes depend upon the extent of improvement in technology and advancement to take place. It is also done to improve upon the skills, capabilities, knowledge of the workers.

## EMPLOYEE RECRUITMENT

Recruitment refers to the process of identifying, attracting, interviewing, selecting, hiring and on boarding employees. In other words, it involves everything from the identification of a staffing need to filling it.

Recruitment is the first step in building an organization's human capital. At a high level, the goals are to locate and hire the best candidates, on time, and on budget. The purpose of the recruitment process is to find talented and qualified individuals for the growth and development of their organization. It is part of the human resource management (HRM) department.

*According to Edwin B. Flippo defined the recruitment process – ‘Recruitment is the process of searching the candidates for employment and stimulating them to apply for jobs in the organization.’*

# Management Science

---

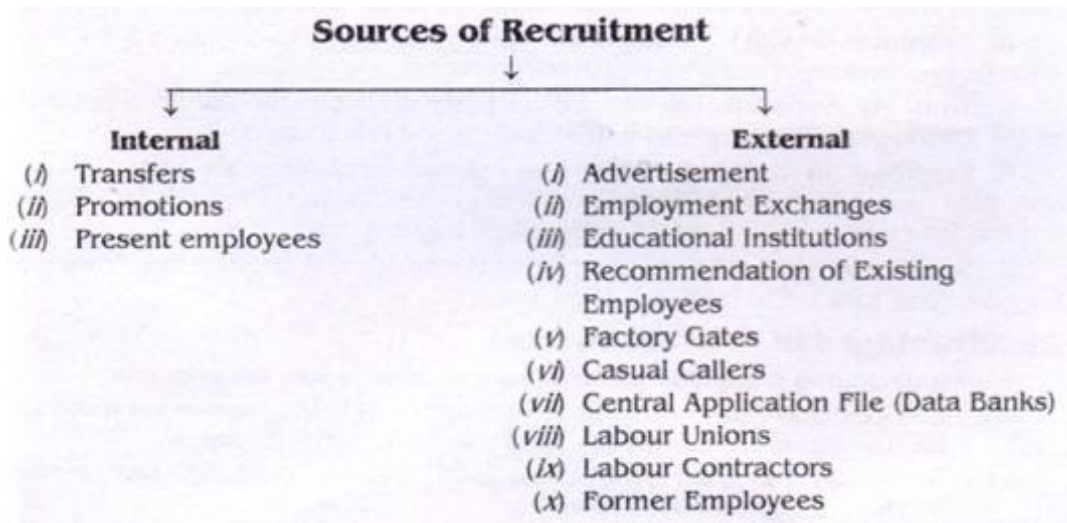

## (A) Internal Sources:

**1. Transfers:** Transfer involves shifting of persons from present jobs to other similar jobs. These do not involve any change in rank, responsibility or prestige. The numbers of persons do not increase with transfers.

**2. Promotions:** Promotions refer to shifting of persons to positions carrying better prestige, higher responsibilities and more pay. The higher positions falling vacant may be filled up from within the organisation. A promotion does not increase the number of persons in the organisation.

A person going to get a higher position will vacate his present position. Promotion will motivate employees to improve their performance so that they can also get promotion.

**3. Present Employees:** The present employees of a concern are informed about likely vacant positions. The employees recommend their relations or persons intimately known to them. Management is relieved of looking out prospective candidates.

## (B) External Sources:

**1. Advertisement:** It is a method of recruitment frequently used for skilled workers, clerical and higher staff. Advertisement can be given in newspapers and professional journals. These advertisements attract applicants in large number of highly variable quality.

**2. Employment Exchanges:** Employment exchanges in India are run by the Government. For unskilled, semi-skilled, skilled, clerical posts etc., it is often used as a source of recruitment. In certain cases it has been made obligatory for the business concerns to notify their vacancies to the employment exchange. In the past, employers used to turn to these agencies only as a last resort. The job-seekers and job-givers are brought into contact by the employment exchanges.

**3. Schools, Colleges and Universities:** Direct recruitment from educational institutions for certain jobs (i.e. placement) which require technical or professional qualification has become a common practice. A close liaison between the company and educational institutions helps in getting suitable candidates. The students are spotted during the course of their studies. Junior level executives or managerial trainees may be recruited in this way.

**4. Recommendation of Existing Employees:** The present employees know both the company and the candidate being recommended. Hence some companies encourage their existing employees to assist them in getting applications from persons who are known to them.

In certain cases rewards may also be given if candidates recommended by them are actually selected by the company. If recommendation leads to favouritism, it will impair the morale of employees.

**5. Factory Gates:** Certain workers present themselves at the factory gate every day for employment. This method of recruitment is very popular in India for unskilled or semi-skilled labour. The desirable candidates are selected by the first line supervisors. The major disadvantage of this system is that the person selected may not be suitable for the vacancy.

**6. Casual Callers:** Those personnel who casually come to the company for employment may also be considered for the vacant post. It is most economical method of recruitment. In the advanced countries, this method of recruitment is very popular.

**7. Central Application File:** A file of past applicants who were not selected earlier may be maintained. In order to keep the file alive, applications in the files must be checked at periodical intervals.

**8. Labour Unions:** In certain occupations like construction, hotels, maritime industry etc., (i.e., industries where there is instability of employment) all recruits usually come from unions. It is advantageous from the management point of view because it saves expenses of recruitment. However, in other industries, unions may be asked to recommend candidates either as a goodwill gesture or as a courtesy towards the union.

**9. Labour Contractors:** This method of recruitment is still prevalent in India for hiring unskilled and semi-skilled workers in brick kiln industry. The contractors keep themselves in touch with the labour and bring the workers at the places where they are required. They get commission for the number of persons supplied by them.

**10. Former Employees:** In case employees have been laid off or have left the factory at their own, they may be taken back if they are interested in joining the concern (provided their record is good).

### SELECTION PROCESS

The selection process can be defined as the process of selection and short listing of the right candidates with the necessary qualifications and skill set to fill the vacancies in an organisation. The selection process varies from industry to industry, company to company and even amongst departments of the same company.

- 1. Preliminary Interview:** This is a very general and basic interview conducted so as to eliminate the candidates who are completely unfit to work in the organisation. This leaves the organisation with a pool of potentially fit employees to fill their vacancies.
- 2. Receiving Applications:** Potential employees apply for a job by sending applications to the organisation. The application gives the interviewers information about the candidates like their bio-data, work experience, hobbies and interests.
- 3. Screening Applications:** Once the applications are received, they are screened by a special screening committee who choose candidates from the applications to call for an interview. Applicants may be selected on special criteria like qualifications, work experience etc.

## Management Science

---

4. **Employment Tests:** Before an organisation decides a suitable job for any individual, they have to gauge their talents and skills. This is done through various employment tests like intelligence tests, aptitude tests, proficiency tests, personality tests etc.
5. **Employment Interview:** The next step in the selection process is the employee interview. Employment interviews are done to identify a candidate's skill set and ability to work in an organisation in detail. Purpose of an employment interview is to find out the suitability of the candidate and to give him an idea about the work profile and what is expected of the potential employee. An employment interview is critical for the selection of the right people for the right jobs.
6. **Checking References:** The person who gives the reference of a potential employee is also a very important source of information. The referee can provide info about the person's capabilities, experience in the previous companies and leadership and managerial skills. The information provided by the referee is meant to be kept confidential with the HR department.
7. **Medical Examination:** The medical exam is also a very important step in the selection process. Medical exams help the employers know if any of the potential candidates are physically and mentally fit to perform their duties in their jobs. A good system of medical checkups ensures that the employee standards of health are higher and there are fewer cases of absenteeism, accidents and employee turnover.
8. **Final Selection and Appointment Letter:** This is the final step in the selection process. After the candidate has successfully passed all written tests, interviews and medical examination, the employee is sent or emailed an appointment letter, confirming his selection to the job. The appointment letter contains all the details of the job like working hours, salary, leave allowance etc.

9.

### Importance of the Selection Process

1. Proper selection and placement of employees lead to growth and development of the company. The company can similarly, only be as good as the capabilities of its employees.

## Management Science

---

2. The hiring of talented and skilled employees results in the swift achievement of company goals.
3. Industrial accidents will drastically reduce in numbers when the right technical staff is employed for the right jobs.
4. When people get jobs they are good at, it creates a sense of satisfaction with them and thus their work efficiency and quality improves.
5. People who are satisfied with their jobs often tend to have high morale and motivation to perform better.

### SELECTION TESTS

**i) Aptitude Tests:** These tests measure whether an individual has the capacity or latent ability to learn a given job if given adequate training. Aptitudes can be divided into general and mental ability or intelligence and specific aptitudes such as mechanical, clerical, manipulative capacity etc.

**(a) Intelligence Tests:** These tests in general measure intelligence quotient of a candidate. In detail these tests measure capacity for comprehension, reasoning, word fluency, verbal comprehension, numbers, memory and space. Other factors such as digit spans — both forward and backward, information known, comprehension, vocabulary, picture arrangement and object assembly.

**(b) Mechanical Aptitude Tests:** These tests measure the capacities of spatial visualization, perceptual speed and knowledge of mechanical matter. These tests are useful for selecting apprentices, skilled, mechanical employees, technicians, etc.

**(c) Psychomotor Tests:** These tests measure abilities like manual dexterity, motor ability and eye-hand co-ordination of candidates. These tests are useful to select semi-skilled workers and workers for repetitive operations like packing and watch assembly.

**(d) Clerical Aptitude Tests:** Measure specific capacities involved in office work. Items of this test include spelling, computation, comprehension, copying, word measuring, etc.



## Management Science

---

**(ii) Achievement Tests:** These tests are conducted when applicants claim to know something as these tests are concerned with what one has accomplished. These tests are more useful to measure the value of specific achievement when an organisation wishes to employ experienced candidates.

**(a) Job Knowledge Test:** Under this test a candidate is tested in the knowledge of a particular job. For example, if a junior lecturer applies for the job of a senior lecturer in commerce, he may be tested in job knowledge where he is asked questions about Accountancy Principles, Banking, Law, Business Management, etc.

**(b) Work Sample Test:** Under this test a portion of the actual work is given to the candidate as a test and the candidate is asked to do it. If a candidate applies for a post of lecturer in Management he may be asked to deliver a lecture on Management Information System as work sample test.

**(iii) Situational Test:** This test evaluates a candidate in a similar real life situation. In this test the candidate is asked either to cope with the situation or solve critical situations of the job.

**(a) Group Discussion:** This test is administered through group discussion approach to solve a problem under which candidates are observed in the areas of initiating, leading, proposing valuable ideas, conciliating skills, oral communicating skills, coordinating and concluding skills.

**(b) In Basket:** Situational test is administered through in basket. The candidate, in this test, is supplied with actual letters, telephone and telegraphic message, reports and requirements by various officers of the organisation, adequate information about the job and organisation. The candidate is asked to take decisions on various items based on the in basket information regarding requirements in the memoranda.

**(iv) Interest Test:** These tests are inventories of the likes and dislikes of candidates in relation to work, job, occupations, hobbies and recreational activities. The purpose of this test is to find out whether a candidate is interested or disinterested in the job for which he is a candidate and to find out in which area of the job range/occupation the candidate is interested.

## Management Science

---

**(v) Personality Tests:** These tests prove deeply to discover clues to an individual's value system, his emotional reactions and maturity and characteristic mood. They are expressed in such traits like self-confidence, tact, emotional control, optimism, decisiveness, sociability, conformity, objectivity, patience, fear, distrust, initiative, judgment dominance or submission, impulsiveness, sympathy, integrity, stability and self-confidence.

**(a) Thematic Apperception Test (TAT):** Candidates are shown a series of pictures and are asked to write a story based on these pictures. This test measured candidates' conceptual, imaginative, projective and interpretative skills.

**(b) Ink-Blot Test:** The Rorschach Inkblot test was first described in 1921. The candidates are asked to see the ink-blot and make meaningful concepts out of them. The examiner keeps a record of the responses, time taken, emotional expressions and other incidental behaviors.

.

**(vi) Other Tests:**

**(a) Cognitive Ability Tests:** These tests measure mathematical and verbal abilities. Popularly known tests of this category include Graduate Record Examination (GRE) and Scholastic Aptitude Test (SAT).

**(b) Wechsler Adult Intelligence Scale:** This is a comprehensive test including general information, arithmetic, similarities, vocabulary, picture completion, picture arrangement, object assembly and similar items.

**(c) Wonderlic Personnel Test:** This test includes perceptual, verbal and arithmetic.

**(d) Polygraph Tests:** The polygraph is an instrument that records changes in breathing, blood pressure, pulse and skin response associated with sweating of palms and plots these reactions on paper. The candidate is asked a series of simple, complicated, related, unrelated and critical questions. This test was used in personnel selection extensively in 1980s, but objections have been raised to the use of this test in personnel selection in 2000s.

(e) **Honesty Tests:** The two types of pre-employment honesty tests are overt integrity tests and personality-based integrity tests. Overt integrity tests make direct questions to assess dishonest behaviour and gather a history of theft and illegal behaviour. Personality-based integrity tests assess an individual's predisposition towards deviant and disruptive behaviour.

## EMPLOYEE TRAINING AND DEVELOPMENT



Employee Training and Development in HRM is defined as a system used by an organization to improve the skills and performance of the employees. It is an educational tool which consists of information and instructions to make existing skills sharp, introduce new concepts and knowledge to improve the employee performance. An effective training & development initiative based on training needs analysis helps the company to enhance the skills of working manpower and improve productivity.

### ***According to Armstrong:***

*“Training is the formal and systematic modification of behavior through learning which occurs as a result of education, instruction, development and planned experience. Development is improving individual performance in their present Roles and preparing them for greater responsibilities in the future”.*

### **Need of Training and Development**

- The training and development activity is required when company revises its objectives and goal to adjust the changing market conditions.
- Companies often endorse training and development programs to improve the performance of the employees.
- The HR training and development is needed to set up a benchmark of performance which employees are expected to achieve in a financial year.
- There is always a need of training and development efforts to teach the employee new skills such as team management, communication management and leadership behavior.

# Management Science

---

- Training and development is also used to test new methods of enhancing organizational productivity.

## **Importance of Training and Development**

- Training and development is a key for the succession planning of the organization as it helps in improvement of skills like team management and leadership.
- HR Training and development activities are vital to motivate the employee and to increase their productivity.
- Training and development in HRM is significant aspect to develop a team spirit in the organization.
- Training and development programs are also important from the safety point of view as it teaches employee to perform job properly without any life risk.
- From the organizational point of view the HR training and development programs are important performance management tool to increase profitability and enhance corporate image.

## **Benefits of Training and Development**

- Investing in staff training and development boosts work satisfaction and morale.
- Employee turnover is reduced.
- Inspires employees to work harder.
- Improves process efficiency, resulting in financial benefit.
- Aids in the adoption of new technology and processes.
- Increases strategy and product innovation

**1. On-the-job Training (OJT) Methods:** This is the most common method of training in which a trainee is placed on a specific job and taught the skills and knowledge necessary to perform it.

# Management Science

---

**1. Job rotation:** This training method involves movement of trainee from one job to another gain knowledge and experience from different job assignments. This method helps the trainee understand the problems of other employees.

**2. Coaching:** Under this method, the trainee is placed under a particular supervisor who functions as a coach in training and provides feedback to the trainee. Sometimes the trainee may not get an opportunity to express his ideas.

**3. Job instructions:** Also known as step-by-step training in which the trainer explains the way of doing the jobs to the trainee and in case of mistakes, corrects the trainee.

**4. Committee assignments:** A group of trainees are asked to solve a given organizational problem by discussing the problem. This helps to improve team work.

**5. Internship training:** Under this method, instructions through theoretical and practical aspects are provided to the trainees. Usually, students from the engineering and commerce colleges receive this type of training for a small stipend.

**2. off-the-job Methods:** On the job training methods have their own limitations, and in order to have the overall development of employee's off-the-job training can also be imparted. The methods of training which are adopted for the development of employees away from the field of the job are known as off-the-job methods.

**1. Case study method:** Usually case study deals with any problem confronted by a business which can be solved by an employee. The trainee is given an opportunity to analyze the case and come out with all possible solutions. This method can enhance analytic and critical thinking of an employee.

**2. Incident method:** Incidents are prepared on the basis of actual situations which happened in different organizations and each employee in the training group is asked to make decisions as if it is a real-life situation. Later on, the entire group discusses the incident and takes decisions related to the incident on the basis of individual and group decisions.

**3. Role play:** In this case also a problem situation is simulated asking the employee to assume the role of a particular person in the situation. The participant interacts with other

## Management Science

---

participants assuming different roles. The whole play will be recorded and trainee gets an opportunity to examine their own performance.

**4. In-basket method:** The employees are given information about an imaginary company, its activities and products, HR employed and all data related to the firm. The trainee (employee under training) has to make notes, delegate tasks and prepare schedules within a specified time. This can develop situational judgments and quick decision making skills of employees.

**5. Business games:** According to this method the trainees are divided into groups and each group has to discuss about various activities and functions of an imaginary organization. They will discuss and decide about various subjects like production, promotion, pricing etc. This gives result in co-operative decision making process.

**6. Grid training:** It is a continuous and phased program lasting for six years. It includes phases of planning development, implementation and evaluation. The grid takes into consideration parameters like concern for people and concern for people.

**7. Lectures:** This will be a suitable method when the numbers of trainees are quite large. Lectures can be very much helpful in explaining the concepts and principles very clearly, and face to face interaction is very much possible.

**8. Simulation:** Under this method an imaginary situation is created and trainees are asked to act on it. For e.g., assuming the role of a marketing manager solving the marketing problems or creating a new strategy etc.

**9. Management education:** At present universities and management institutes gives great emphasis on management education. For e.g., Mumbai University has started bachelors and postgraduate degree in Management. Many management Institutes provide not only degrees but also hands on experience having collaboration with business concerns.

**10. Conferences:** A meeting of several people to discuss any subject is called conference. Each participant contributes by analyzing and discussing various issues related to the topic. Everyone can express their own view point.

# Management Science

---

## PERFORMANCE APPRAISAL

Performance Management is the managerial process that deals with the various dimensions of the performance of the employees which include the identification of the resources to be provided to the employees, evaluation of the employees at regular intervals of time and delivering feedback to them, planning the rewards and incentives, etc.

- Performance Appraisal deals with the evaluation part of performance management.
- It involves the systematic evaluation of an employee with regard to their contribution to the organization. Performance appraisal takes the behaviour, attitude, skill-set and knowledge improvement, learning potential and other factors into consideration.
- Performance appraisal is the process of assessment of the job performance of the employees by taking specific metrics into consideration by the supervisors or any other assigned team members.
- It involves the comparison of the performance of an employee with their own performance and with the performance of the other employees over a specific period of time.

### Objectives of Performance appraisal

- Helping the organization over promotions, salary increments, incentives, internal job transfers, terminations, improving training modules, etc.
- Providing evaluation feedback to employees, to state what is required from them and what the areas they need to improve are.
- Creating a friendly environment by assessing the difficulties faced by the employees and motivating them.

## METHODS OF PERFORMANCE APPRAISAL

### A. Traditional Methods

**1. Ranking method:** In this method, the employees are ranked by taking their performance levels and other characteristics into consideration.

# Management Science

---

- Very useful to divide a good and an average performer.
- Can be used easily for a small set of employees.
- The ranking becomes difficult when a large set of employees have similar characteristics.

**2. Grading method:** In this method, different grades are given to the employees based on their contribution to the organization.

- Grades may be in the form of alphabets (A, B, C, D, E, F..) or in words like excellent, very good, moderate, bad, very bad, worst or excellent, good, bad.
- Based on the grades given, promotions, hikes, training, etc. are planned.

**3. Paired comparison method:** In this method, the appraiser compares two employees and marks the better performer. The process is continued until all the employees are compared with one another in this manner.

- After the entire process is completed, ranking is given to all the employees based on the number of times that the employee has been marked as a better performer.
- This method is very difficult for an organization that has a large number of employees.

**4. Forced choice method:** In this method, the appraiser is given a set of statements and asked to select one statement which defines the employee.

- Let us consider the following three statements,
  - He/ She is a team player.
  - He/ She needs to be trained to improve the skill set.
- The appraiser has to select one statement as a part of the evaluation process.
- This is a time-consuming method.

**6. Graphical rating method:** In this method, different characteristics of the employees are rated. The appraiser rates the employees on each characteristic in the form of points like 1, 2, 3, 4, 5, 6, and 7 or in the form of excellent or average or bad, etc.

- Let us consider two characteristics like efficiency and training. If an employee performs very well in the training sessions, then that employee will be given the rating as 6 or 7 on 7 point scale.



# Management Science

---

- If the same employee performs poorly on the project related tasks, then that employee will be given 2 points or 1 point for efficiency.

**6. Forced distribution method:** In this method, the appraiser has to distribute the employees into five levels like excellent, very good, average, very bad and worst performers.

- For example, if there are 1000 employees, the appraiser has to distribute the employees into various categories as per their performance levels.
- If there are 200 excellent performers, they fall into the excellent category. If the performance levels of another 200 employees are not up to the mark, then they fall into the very bad category. This method is continued until every employee is distributed into some category.

**7. Checklist method:** In this method, all the characteristics in the question form are written in order and two options yes and no is given to the appraiser for every question. The appraiser has to tick the yes box when the given characteristic is found and no box when it is not.

- All the responses are counted, and a final rating is obtained.
- It is a time taking process and not accurate.

**8. Essay method:** In this method, the appraiser writes about the characteristics of the employee in his own words in the form of an essay.

- With this, the strong and weak points can be easily known.
- But the essay depends on the writing skills of the appraiser. Sometimes, there may be a chance of weak areas getting more highlighted than the strong areas of an employee. This may de-motivate the employee.

**9. Critical incidents method:** In this method, the performance of the employees during critical incidents is taken into consideration.

- All the critical tasks performed by each employee are written and are compared with each other by the appraisal team.
- The rating is done based on the severity of the critical incident.

**10. Field review method:** In this method, the appraiser takes the help of subordinates and supervisors to rate an employee.

# Management Science

---

- This method is mostly used during the promotions and increments.
- It is a time-consuming process.

## B. Modern Methods

**1. Management by Objectives (MBO):** This method was developed by Peter F. Ducker. In this method, certain tasks (objectives) based on their job role are given to the employees and a team is assigned to monitor the tasks.

- This will help the organization to know the skill gap of the employees.
- This will help the organization to plan the training modules.
- The setting of objectives to determine the true potential of the employees is a difficult and time-consuming task.

**2. 360-degree appraisal:** In this method, an employee is appraised by the supervisors, the clients, the subordinates, the customers, including themselves.

- This will help the organization to know about the strong and weak areas of the employees.
- The employees can freely express their views and suggest any changes in the training methods.

**3. Assessment centers:** In this method, a group of employees are selected and are asked to perform a few tasks individually and a few tasks in teams.

- These tasks are mainly aimed to check the teamwork, leadership qualities and skill set of the employees.
- The tasks are mostly related to their job responsibilities.
- This method is used to decide whether an employee is to be promoted or trained.

**4. Behaviorally Anchored Rating Scales (BARS):** In this method, all the critical incidents are identified and are divided into different groups based on their departments.

- The employees are rated on their behaviour towards the incidents rather than on the traits.
- This will enable the organization to know the involvement of the employees.

# Management Science

---

## PLACEMENT

Placement is a process of assigning a specific job to each of the selected candidates. It involves assigning a specific rank and responsibility to an individual. It implies matching the requirements of a job with the qualifications of the candidate. Placement is understood assigning jobs to the selected candidates. Assigning jobs to employees may involve a new job or different jobs. Thus, placement may include initial assignment of job to new employee, on transfer, promotion or demotion of the present employees.

### **Right placement of workers can have the following advantages:**

1. Reduced labor turnover rate.
2. Reduced absenteeism rate.
3. Increased safety of workers and lower accidents.
4. Increased morale of workers.
5. Better human relations in the organizations

### **Principles:**

**1. Job Requirements:** An employee should be placed on the job according to the requirements of the job such as physical and mental ability, eyesight, hearing, stress etc. The job shouldn't be adjusted according to the qualification and abilities of the employees. Job placement profile charts can be used to match the worker's physical and mental abilities with the job requirements. This profile chart displays an evaluation of both job requirements and worker abilities for key features of the job so that the management can easily determine how well worker fits a job.

**2. Suitable Qualifications:** The job should be offered to only that person who is suitably qualified. Over qualified and under qualified persons might create problems for the organisation in the long run.

**3. Adequate Information to the Job Incumbent:** The employee should be provided with the complete information and facts relating to the job, including the working conditions prevailing in the firm. He should also be made known to the rewards associated with the performance levels.

**4. Commitment and Loyalty:** While placing the new employee, an effort should be made to develop a sense of commitment, loyalty and cooperation in his mind so that he may realize his responsibilities better towards the job, the organisation and his associates.

**5. Flexibility:** The placement in the initial period may be temporary as changes are likely after the completion of training. The employee may be later transferred to the job where he can do better justice.

### INDUCTION



*According to Edwin B.Flippo, “Induction is concerned with introducing or orienting a new employee to the organisation. It is the welcoming process to make the new employee feel at home and generate in him a feeling of belongingness to the organisation”.*

It is the first step in a proper communication policy which seeks to build a two-way channel of information between the management and employees. The new employee, on his joining the organisation, must be helped to get adjusted and acquainted with the fellow employees and the work environment. Rather than leaving him to make his own way through the organisation.

### Contents of Induction Program

1. Company’s history, mission, vision and philosophy.
2. Products and services of the company.
3. Company’s organisation structure.
4. Location of departments and employee services.
5. Employee’s activities like clubs, credit society.
6. Personnel policies and procedures.
7. Standing orders.
8. Rules and Regulations.
9. Terms and conditions of services.
10. Grievance procedures.

11. Safety measures.
12. Benefits and services for employees.
13. Training, promotions and transfer facility.
14. Career advancement schemes.
15. Counseling facility.

## **STEPS IN INDUCTION PROCESS:**

- (1) **Welcoming the New Employees:** The first fundamental step in induction is welcoming the new employees as soon as he joins the organizations and is duly placed on the job and gives basic instruction.
- (2) **Induction with Immediate Superior:** After welcome of the new employees, the next step is to introduce him with his immediate superior or with his colleagues and briefly explains his duties, responsibilities authorities, work procedure and practices.
- (3) **To Impart Detail Instructions:** The third and last important step in induction is to give detail information about the company such as company policies, plans, targets objectives, goals, products services, future prospects, working environment, future facilities, salary structure promotional opportunities, transfer facilities etc. At this stage a new comer knows his job and forms opinion about it, of course which is positive and starts integrating himself with the organization his job and the environment.

## **WAGE AND SALARY ADMINISTRATION**

Wage and salary administration is a collection of practices and procedures used for planning and distributing company-wide compensation programs for employees. These practices include employees at all levels and are usually handled by the accounting department of a company.

### **Nature:**

1. The basic purpose of wage and salary administration is to establish and maintain an equitable wage and salary structure.

# Management Science

---

2. It is concerned with the establishment and maintenance of equitable labor cost structure i.e. an optimal balancing of conflicting personnel interest so that the satisfaction of the employees and employers is maximized and conflicts are minimized.
3. The wage and salary administration is concerned with the financial aspects of needs, motivation and rewards.
4. Employees should be paid according to the requirements of their jobs i.e. highly skilled jobs are paid more compensation than low skilled jobs.
5. To minimize the chances of favouritism.

## Characteristics

1. Payment of wages is in accordance with the terms of contract between the employer and the worker.
2. The wages are determined on the basis of time-rate system or piece-rate system.
3. Wages change with the change in the time spent by the laborer.
4. Wages create utility.
5. Wages may be paid weekly, fortnightly, hourly, or on monthly basis.
6. Wage is the reward paid to the workers for the services rendered by them.
7. Wages can be paid in cash or in kind. 8. All kinds of allowances are included in wages.

## Objectives:

1. To compare or draft company HR policy
2. Find out the income level and return ratio of similar industries
3. To understand wage differentiations
4. To examine the competitiveness of entry level employees
5. To establish hiring rates favorable to the community
6. To keep abreast wage and salary rates with production cost
7. To minimize labor turnover due to pay disparity
8. To increase employee's satisfaction and morale
9. To learn about the trend of perks and benefits in the market
10. To resolve existing labour problems concerning compensation.

---

# Management Science

---

## TYPES OF COMPENSATIONS

### I. Financial Compensation:

**1. Direct Financial Compensation:** Financial compensation means monetary payment made to an employee in exchange for his work. This includes basic pay, bonus, incentives, overtime payment, commission and variable pay.

- a. **Basic Pay** – It is the direct financial compensation an employee gets for the time worked. It takes the form of wage or salary.
- b. **Incentives** – It is a plan that links pay to productivity or profitability. It may be linked to the performance of an individual or a team or the entire organizational level performance. Bonus, profit-sharing plan, variable pay and stock options are examples of incentive plans.

**2. Indirect Financial Compensation:** It includes benefits like pensions, insurance, paid holidays. These benefits are available to all employees.

**Benefits:** They are employer-provided other than wages, salaries, or incentives. They make up indirect component of a financial compensation plan. These benefits are not performance-based and are awarded to all employees by virtue of their membership in a given organization.

**They are of two types:**

1. Mandatory and
2. Voluntary

**1. Mandatory Benefits:** These benefits are legally binding on an employer to provide to the employees., viz., Provident fund, gratuity scheme, health plan, maternity leave, medical leave, etc., are examples of these benefits.

**2. Voluntary Benefits:** These are discretionary and provided by the employer voluntarily. These include compensation for' time not worked, for example, paid

holidays, family-friendly benefits, retirement benefits, etc. Organizations today offer their employees benefits like sabbaticals, Childcare centers, work from home option, job search facility for spouse, health/life/accident insurance, company-sponsored education facility, Free transport, subsidized meals, free concierge services by which employees have their telephone, electricity bills, etc., paid.

**II. Non-Financial Compensation:** These are psychological rewards given to employees who entertain a feeling that their skills are recognized. Employees at senior and middle levels who prefer to work on high end technology, desire empowerment. Besides recognition awards and service awards there are also other important non-financial compensations given to employees by contemporary employers.

**They are:**

- 1. Awards** – Awards include cash, gift certificates, movie tickets, parties and dinner coupons for family members, travel concessions to famous destinations, etc.
- 2. Recognition awards** – Felicitation award for employee of the month and employee of the year given at a colorful event have the potential to motivate the employees for better performance. Individuals who make contribution to society, work beyond the call of duty or whose ideas have impact on business are given suitable awards.
- 3. Service awards** – Employees who have completed a certain number of years become eligible for loyalty award.
- 4. Appreciation** – When an employee performs the job to the full satisfaction of superiors, appreciation of superior in the presence of colleagues is a sure-fire reward for the employees.
- 5. Challenging task** – Assignment of a challenging task to the promising employees has the potential to unlock latent talent in the employees concerned.
- 6. Deputation for foreign assignment** – Selection of best performing employees for training and for important overseas assignment would certainly trigger their motivation and it adds to their value and prestige among their colleagues.



## Management Science

---

**7. Seeking consultation** – Consulting key employees on strategic issues and seeking their honest opinion has a tremendous bearing on their morale and positive energy.

**8. Participatory opportunity** – Employees participation in decision-making, in the form of joint decision-making autonomous workgroup, consultative committees, kaisen management, collective bargaining, quality circles, suggestion committees and so on would indubitably kindle their enthusiasm and impel them to contribute positively towards the goal of the organization.

**9. Power delegation and decentralization** – Decentralization of power to employees, fixation of accountability, delegation of authority have the power to enable the employees to unleash their otherwise dormant potentials.

**10. Conducting of refresher training** – Conducting frequent training to freshen up the knowledge skill, competency of employees has the potential to empower the employers and recharge their energies.

**11. Liberal holidays** – Providing various type of holidays and sabbatical is one of the powerful motivations for employees.

**12. Alternate work schedule** – Alternate work schedule like part time work, job sharing, flexi time, annulated work hours, work from home, option to work in day shift, etc., go a long way towards sustaining the loyalty of employees.

## UNIT – IV- A - STRATEGIC MANAGEMENT

Strategy is concerned with deciding which alternative is to be adopted to accomplish the overall objectives of the organization. Strategy is a Comprehensive long term plan.

It tries to answer three main questions:

- What is the present position of the firm?
- What should be the future position of the firm?
- What should be done to attain the future position?

### **Definition:**

*According to Alfred D Chandler:* “Strategy is the determination of the basic long-term goals & objectives of an enterprise & the adoption of the course of action and the allocation of the resources necessary for carrying out these goals”

### **Nature & Characteristics of Strategies:**

- 1. Objective Oriented** - Strategies are developed in order to achieve the objectives of the organization. To formulate strategies, one has to know the objectives that are to be pursued & also the policies that must be followed.
- 2. Future Oriented** - Strategy is a future oriented plan. It is designed to attain future position of the organization. Through Strategy, management studies the present position of the organization & their aims at attaining the future position of the organization.
- 3. Unified, Comprehensive and Integrated** - A Strategy is not Just plan. It is a unified, Comprehensive & integrated plan. It is unified as it unifies all the parts of sections of the organization together. It is comprehensive as it covers all the major aspects or areas of the organization.
- 4. Alternatives Strategies** - Organizations need to frame alternative strategies. It is not sufficient to frame one or two strategies. Small organizations survive with one or two

# Management Science

---

strategies due to fewer complexities in their business. However, large organizations need to frame alternative strategies in respect of growth & survival of the organization.

**5. Relates to the Environment** - The internal and external environment affects the strategy formulation & implementation. The internal environment relates to mission & objectives of the firm, the labor management relations, and the technology used, the physical, financial & human resources. The external environment relates Competition, Customer, Channel, intermediaries, Government policies & other social, economic & political factors.

**6. Allocation of Resources** - For effective implementation of Strategy, there is a need for proper allocation of the resources. Proper allocation of resources is required to undertake the various activities so as to attain objectives.

**7. Universal Applicability** - Strategy is universally applicable. It is applicable to business organization as well as to non-business organization. This is because every organization needs to frame strategies for their growth & survival.

## Strategic Management

*According to Jauch & Glueck: "Strategic Management is a stream of decisions & actions which leads to the development of an effective strategy or Strategies to help achieve corporate objectives The Strategic Management process is the way in which strategists determine objectives & make strategic decisions"*

## SETTING of VISION - MISSION - GOALS

### VISION

Vision is a descriptive image of what the company wants to be or want to be known for. Vision reminds us of what the goals are, without vision performance of the business is likely to be affected.

A vision is a statement for where the organization is heading over the next five to ten years. It is the statement that indicates mission to be accomplished by the management in distant future.

# Management Science

---

*Warren Bennis and Burt Nanus described the role of vision as follows:*

“To choose a direction, a leader must first have developed a mental image of a possible and desirable future state of organization, which we call a vision. Vision articulates a view of a realistic/ credible, attractive future for the organization. With a vision, the leader provides an important bridge from the present to the future of the organization.

## **Characteristics of an Effective Vision Statement:**

1. **Graphic:** The vision should draw a picture that can reveal where the company is heading and can also indicate clearly the market position.
2. **Directional:** It is able to provide clear direction to the managers and employees as well as describe a forward-looking picture of the company.
3. **Focused:** It can specifically guide managers in decision making and allocating resources of the company.
4. **Flexible:** It must be flexible enough so that with changes in the products or technology or market, the vision itself can also be changed to keep pace with the changing situations.
5. **Feasible:** It should portray an expectation for the future that is achievable – not just spelling out an expectation for the sake of telling about an expectation.
6. **Desirable:** It should be able to indicate; ‘why the chosen path makes good business sense’.
7. **Easy to communicate:** The vision must be worded in such a way that it can be communicated easily to the stakeholders, especially the shareholders, employees, and customers.

## **MISSION**

All management experts unanimously agree that clarifying the mission and defining the business is the starting point of business planning. Many organizations define the basic reason for

# Management Science

---

their existence in terms of a mission statement. An organization's mission includes both a statement of organizational philosophy and purpose.

The mission can be seen as a link between performing some social function and attaining objectives of the organization. A well-conceived mission statement defines the fundamental, unique purpose which sets a company apart from the other firms of its type and identifies the scope of the firm's operation in terms of the product/ services offered and the markets served. It may also include the firm's philosophy about how it does the business and treats the employees.

**Ex:** The mission of General Motors states “ The fundamental purpose of General Motors is to provide products and services of such quality that our customers will receive superior value, our employees and business partners will share in our success and our stock holders will receive a sustained, superior return on their investment.

Some management experts consider vision and mission as two different concepts. They are of the view that a mission statement describes what the organization is now and a vision statement describes what the organization would like to be in future. However, we would like to include the vision concept in the mission statement. Therefore a mission statement tells who we are & what we would like to become.

## **Characteristics of an Effective Mission Statement:**

**1) Clarity:** It should be clear and easy to understand the philosophy and purpose of the organization. It should be clear to everyone in the organization so that it acts as a guide to action. However, it is to be noted that clear mission statement by itself does not ensure success; it only provides a sense of purpose and direction.

**2) Feasibility:** It should not state impossible tasks. A mission statement should always aim higher but not impossible goals. It should state a purpose which should be realistic and attainable. A company should always consider its abilities and resources before making a mission statement.

**3) Current:** It may become outdated after sometime. A mission statement may hold good for a certain number of years say 10 year. Very few definition of purpose and mission of a

# Management Science

---

business have anything like a life expectancy of thirty, let alone fifty years. It should be modified or revised taking into consideration the change in the internal and external environment.

**4) Enduring:** It should be a motivating force guiding and inspiring the individuals in the organization for higher and better performance. For instance, mission statement of education institution may state “higher and still higher achievements” may motivate the individuals in the institution.

**5) Distinctive:** It should be unique and distinctive. It should not appear similar as compared to the other competitors or companies. It is true that the mission statement of most companies aim higher in terms of market share, service to the customers, quality products & service, but the drafting of the mission statement must be done in such words that it brings uniqueness to the mission statement.

**6) Precise:** It should contain few words and not a very long statement. It should sound good and look good. It should be a very attractive statement. This does not mean that it should contain only two to three words.

## GOALS

A business owner's simplest goal is to be successful and make money. However, this isn't enough to make your business successful. You need to set well-defined goals that measure short-term, midterm and long-term success. You may also want to break goals into sales, marketing, development and company employee growth.

Most businesses use the SMART model for goal setting: Specific, Measurable, Achievable, Relevant and Timed. These are specific characteristics used in successful goal setting.

## Characteristics of an SMART GOAL

1. A goal is **measurable:** to the extent that whether the goal is achieved can be quantified. President Kennedy’s goal of reaching the moon by the end of the 1960s offered very simple and clear measurability.

# Management Science

---

2. A goal is **aggressive**: if achieving it presents a significant challenge to the organization. A series of research studies have demonstrated that performance is strongest when goals are challenging but attainable. Such goals force people to test and extend the limits of their abilities.
3. **Specificity**: Strategic goals are more specific than, let's say, your role statement, but then can't be too specific either, since you don't want too many of them in your strategic plan.
4. **Reflective**: Your strategic goals need to reflect the analytical work done in the rest of the strategic planning process. They need to be based on your best understanding of your business environment, strengths, abilities, opportunities and so on.

## Corporate Planning Process

Corporate planning is a process that is used by businesses to map out a course of action to grow, increase profits, gain exposure, or strengthen brand identity. Corporate planning is a tool that successful businesses use to leverage their resources more wisely than their competitors.

### Need for corporate planning

A plan is not only beneficial to keep your business organized, but it can also help increase -

- Clarity & Direction
- Ensure efficiency use of resources
- Provide a way of measuring progress
- Support effective decision-making
- Coordinate activities
- Allocate responsibilities
- Motivate and guide staff

### Process of Corporate Planning:

(i) **Environmental Analysis and Diagnosis**: The first steps (which is, in fact, the background step), involved in corporate planning is environmental analysis and diagnosis. (A detailed account of this step is attempted subsequently, in the discussion about corporate planning).

**(ii) Determination of Objectives:** All planning starts with a determination of the objectives for the plan; and corporate planning is no exception to this generality. In corporate planning, after environmental analysis and diagnosis, the planners determine objectives for the company as a whole and for each department of it; which become the beginning point of corporate planning.

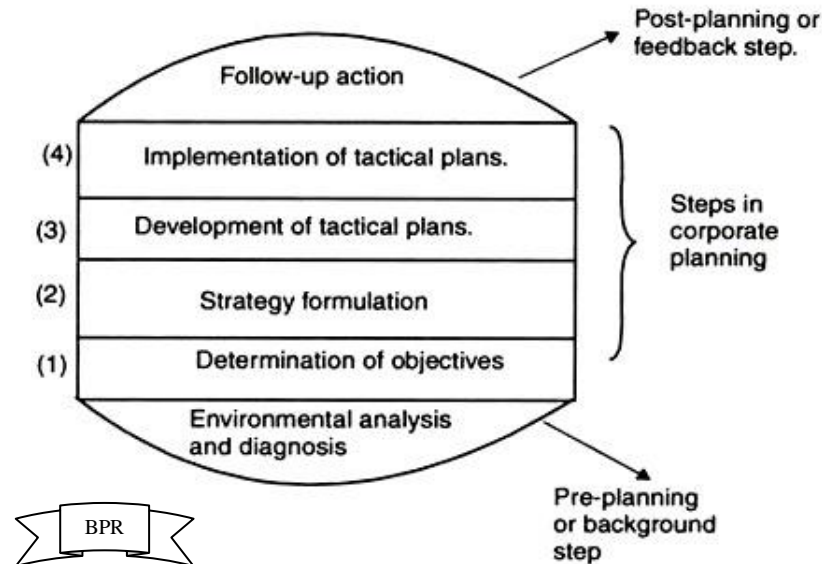

**(iii) Strategy Formulation:** Strategy formulation is the core aspect of corporate planning. Strategy is, in fact, the weapon of the planner devised for attaining objectives of corporate planning. It is easier to set objectives; it is difficult to realize them. Strategies facilitate the attainment of objectives.

**(iv) Development of Tactical Plans:** Strategies are translated into action plans called tactical plans or operational plans. Tactical plans are necessary for implementation of strategies leading to the attainment of corporate planning objectives. For example, if the strategy of a company is to develop the skills and talents of manpower for realizing objectives; then designing of suitable training programmes would amount to making tactical plans.

**(v) Implementation of Tactical Plans:** Mere paper planning is no planning; unless and until it is put into practice. As such, tactical plans are put into a process of



## Management Science

---

implementation, just at the right time, as decided by management. For implementation purposes, necessary communications are made to the operating staffing; who are also provided with necessary facilities to implement the tactical plans.

**(vi) Follow-Up-Action:** After the tactical plans have been put into practice; a review of progress is done i.e. an examination of what results are following from the implementation of the plan and what feedback action is necessary, for the betterment of the corporate planning process.

### ENVIRONMENTAL SCANNING

The purpose of the scan is the identification of opportunities and threats affecting the business for making strategic business decisions. As a part of the environmental scanning process, the organization collects information regarding its environment and analyzes it to forecast the impact of changes in the environment. This eventually helps the management team to make informed decisions.

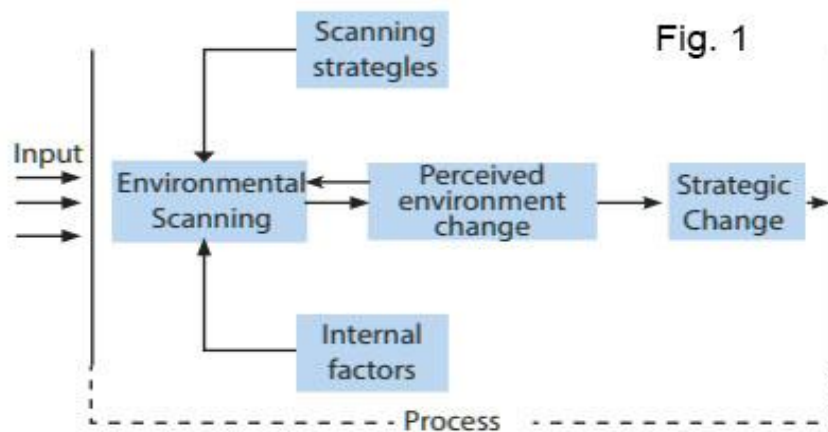

As seen from the figure above, environmental scanning should primarily identify opportunities and threats in the organization's environment. Once these are identified, the organization can create a strategy which helps in maximizing the opportunities and minimizing the threats.

## Characteristics of Environmental Scanning

1. **Continuous Process-** The analysis of the environment is a continuous process rather than being sporadic. The rapidly changing environment has to be captured continuously to be on track.
2. **Exploratory Process-** Scanning is an exploratory process that keeps monitoring the environment to bring out the possibilities and unknown dimensions of the future. It stresses the fact that “What could happen” and not ”What will happen”.
3. **Dynamic Process-** Environmental scanning is not static. It is a dynamic process and depends on changing situations.
4. **Holistic View-** Environmental Scanning focuses on the complete view of the environment rather than viewing it partially

## Components of Environmental Scanning

1. **Internal Environmental Components-** The components that lie within the organization are internal components and changes in these affect the general performance of the organization. Human resources, capital resources and technological resources are some of the internal environmental components.
2. **External Environmental Components:** The components that fall outside the business organization are called external environmental components. Although the components lie outside the organization, they still affect the organizational activities. The external components can be divided into micro environmental components, and macro environmental components.

## Importance of Environmental Scanning

- **Goal Accomplishment:** The objectives of an organization cannot be fulfilled unless it adapts itself to environmental changes. One has to adjust the strategies to fit in the changing demands of the environment.

# Management Science

---

- **Threats and Weakness Identification:** For an organization to grow, it must minimize its threats and identify its weaknesses. This is made possible with the help of environmental scanning with which better strategies can be developed.
- **Future Forecast:** Environmental changes are often unpredictable. An organization cannot anticipate all the future events but based on the analysis, it can make better strategic decisions in the future. Hence, environmental analysis helps to forecast the prospects of the business.
- **Market Knowledge:** Every organization must be aware of the ongoing changes in the market. If it fails to incorporate strategic changes due to changing demands, it will not be able to achieve its objectives.
- **Focus on the Customer:** Environmental scanning and analysis make an organization sensitive to the changing needs and expectations of the customer.
- **Opportunities Identification:** With the analysis of the current environment, an organization will be able to identify the possible opportunities and take necessary steps.

## Strategy Formulation

Strategy formulation is the process of selecting the most appropriate and efficient ways to realize an organization's vision and help it realize its goals and objectives. The strategy formulation process is a part of strategic management and involves using several analytical tools to figure out the best way to use an organization's resources. Strategy formulation allows an organization to create a financial blueprint for creating profits and being sustainable in the long haul.

The most popular way of examining a strategy formulation process is through the SWOT analysis. SWOT is an acronym for strengths, weaknesses, opportunities and threats. It provides a detailed and comprehensive analysis on strategy formulation and helps an organization determine whether a particular strategy is fit to be implemented.

**Levels of Strategy Formulation:** There are three levels of strategy formulation, also known as the three types of strategy formulation. These levels of strategy formulation refer to the different ways in which strategizing can take place at an organization:

# Management Science

---

**1. Corporate Level Strategy:** This is among the most important types of strategy formulation as it's used to outline the precise requirement of an organization—growth, acquisition, stability or retrenchment. This in turn shapes the nature of the work that an organization does, the timeline it has to follow and the resources that are at its disposal.

**2. Business Level Strategy:** As one of the levels of strategy formulation that requires the most research and investment of time and personnel, the business level strategy has a specific purpose. That purpose is to answer the question—how exactly is an organization going to compete? This takes into account an organization's abilities to expand and retain a competitive edge in the market. This type of strategy formulation is particularly useful for those organizations that have several small units of business, each one of which is considered to be a strategic business unit (SBU).

**3. Functional Level Strategy:** This level of strategy is concerned less with ideation and more with logistical management and execution. The focus of this level is primarily on growth and how daily actions, including allocation of resources, can help deliver corporate and business level strategies for the organization to reach its business goals.

## Steps Of Strategy Formulation

There are six separate steps that are recognized as part of the strategy formulation process. Each of these steps of strategy formulation has a specific role to play, although it's not mandatory for the steps to follow a specific chronology to be effective. Let's take a closer look at all the steps of strategy formulation with a brief explanation for each.

**1. Determining Organizational Objectives:** The primary purpose of strategic formulation is to set down certain objectives that an organization tries to meet. Objectives may be ambitious or modest, but in either case, they must be spelt out with the help of a detailed plan that shows how these objectives can be realized by the organization. When determining organizational objectives, strategy formulation also takes care of the time periods when particular objectives have to be met or discarded, in case they're no longer feasible within the scope of the industry concerned.

## Management Science

---

**2. Assessing the Organizational Environment:** The second step of strategy formulation involves assessing the industrial and economic environment in which an organization operates. This means that competitors within an industry need to be observed, tracked and analyzed. In addition to that, regular qualitative and quantitative reviews of an organization's products or services must be carried out.

**3. Fixing Quantitative Targets:** This step requires organizations to fix quantitative targets that they must meet in a particular quarter or financial year. These targets provide useful information about the long-term value of customers to an organization as well as the performance trajectories of various product or service zones and operating departments across an organization.

**4. Divisional Plans and Contributions From Different Departments:** For this step, each department or division or product or service category present in an organization is identified and evaluated for its performance and adherence to strategic planning. This is done not only for the department in question but also for each of the sub-units under a single department.

**5. Performance Analysis:** As part of this step, organizations are required to identify and analyze the gap between desired performance and actual performance. This is done on the basis of performance data, customer feedback, employee suggestions as well as a general survey of the trends and patterns present in an organization. This step is vital to build connections between what an organization has done in the past, how it's faring in the present and what it can accomplish in the future.

**6. Choice of Strategy:** The previous five steps of strategy formulation are supposed to culminate in the sixth and final step of deciding the actual strategy for an organization. To pick the best course of action, this step requires active and careful consideration of organizational strengths and weaknesses, potential, limitations as well as the presence of internal and external opportunities for that organization.

## SWOT ANALYSIS

**SWOT Analysis** is the most renowned tool for audit and analysis of the overall strategic position of the business and its environment. Its key purpose is to identify the strategies that will create a firm specific business model that will best align an organization's resources and capabilities to the requirements of the environment in which the firm operates. The four factors (Strengths, Weaknesses, Opportunities and Threats) is given below

- 1. Strengths** - Strengths are the qualities that enable us to accomplish the organization's mission. These are the basis on which continued success can be made and continued/sustained. Strengths can be either tangible or intangible. These are what you are well-versed in or what you have expertise in, the traits and qualities your employees possess (individually and as a team) and the distinct features that give your organization its consistency.

Strengths are the beneficial aspects of the organization or the capabilities of an organization, which includes human competencies, process capabilities, financial resources, products and services, customer goodwill and brand loyalty.

Examples of organizational strengths are huge financial resources, broad product line, no debt, committed employees, etc.

- 2. Weaknesses** - Weaknesses are the qualities that prevent us from accomplishing our mission and achieving our full potential. These weaknesses deteriorate influences on the organizational success and growth. Weaknesses in an organization may be depreciating machinery, insufficient research and development facilities, narrow product range, poor decision-making, etc. They must be minimized and eliminated.

For instance - to overcome obsolete machinery, new machinery can be purchased. Other examples of organizational weaknesses are huge debts, high employee turnover, complex decision making process, narrow product range, large wastage of raw materials, etc.

# Management Science

---

- 3. Opportunities** - Opportunities are presented by the environment within which our organization operates. These arise when an organization can take benefit of conditions in its environment to plan and execute strategies that enable it to become more profitable. Organizations can gain competitive advantage by making use of opportunities.

Organization should be careful and recognize the opportunities and grasp them whenever they arise. Opportunities may arise from market, competition, industry/government and technology. Increasing demand for telecommunications accompanied by deregulation is a great opportunity for new firms to enter telecom sector and compete with existing firms for revenue.

- 4. Threats** - Threats arise when conditions in external environment put at risk, the reliability and profitability of the organization's business. They compound the vulnerability when they relate to the weaknesses. Threats are uncontrollable. When a threat comes, the stability and survival can be at stake. Examples of threats are - unrest among employees; ever changing technology; increasing competition leading to excess capacity, price wars and reducing industry profits; etc.

## **Advantages of SWOT Analysis**

- a. It is a source of information for strategic planning.
- b. Builds organization's strengths.
- c. Reverse its weaknesses.
- d. Maximize its response to opportunities.
- e. Overcome organization's threats.
- f. It helps in identifying core competencies of the firm.
- g. It helps in setting of objectives for strategic planning.

## **Limitations of SWOT Analysis**

- a. Price increase;
- b. Inputs/raw materials;

# Management Science

---

- c. Government legislation;
- d. Economic environment;
- e. Searching a new market for the product which is not having overseas market due to import restrictions; etc.

### ***Internal limitations may include-***

- a. Insufficient research and development facilities;
- b. Faulty products due to poor quality control;
- c. Poor industrial relations;
- d. Lack of skilled and efficient labor; etc

## **4. B.PROJECT MANAGEMENT**

Network A network is a graphic representation of a project's operations and a composed of activities and events that must be completed to reach the end objective of a project, showing the planning sequence of time accomplishment, their dependence and inter-relationship.

### **Network Diagram Representation**

**Event-** An event represents the start (beginning) or completion (end) of some activity and as such it consume no time. It has no time duration and does not consume any resources. It is also known as a node. An event is generally represented on the network by a circle.

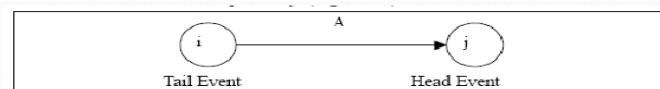

**Activity-** An activity is a task, or item of work to be done, that consume time, effort, money or other resources. An activity is represented by an arrow with its head indicating the sequence in which the events are to occur. The activity can be further classified into the following three categories

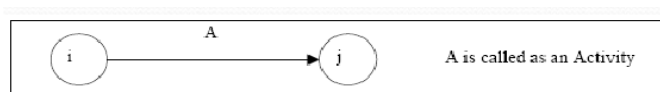



# Management Science

---

1. **Predecessor activity**- An activity which must be completed before one or more other activities start is known as predecessor activity

2. **Successor activity**- An activity which started immediately after one or more of other activities are completed is known as successor activity.

3. **Concurrent activity** – Activities which can be accomplished concurrently are known as concurrent activities. It may be noted that an activity can be a predecessor or a successor to an event or it may be concurrent with one or more of other activities.

4. **Dummy activity**- An activity which does not consume either any resource or time is known as dummy activity. A dummy activity is depicted by dotted line in the network diagram.

For example, consider a situation where A and B are concurrent activities. C is dependent on A and D is dependent on A and B both. Such a situation can be handled by using a dummy activity as shown in the figure:

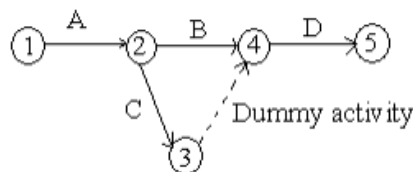

**PERT and CPM** are two statistical tools used to schedule and plan tasks or activities within a project. These methods are utilized to control time, resources, output and several other aspects of a project.

## Rules for Drawing Network Diagram

### **Rule 1**

Each activity is represented by one and only one arrow in the network

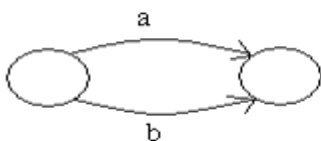

## Rule 2

No two activities can be identified by the same end events

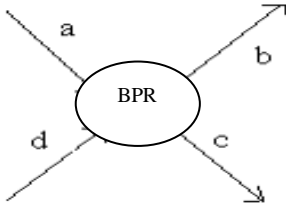

## Rule 3

In order to ensure the correct precedence relationship in the arrow diagram, following questions must be checked whenever any activity is added to the network

- What activity must be completed immediately before this activity can start?
- What activities must follow this activity?
- What activities must occur simultaneously with this activity?

## Common Errors in Drawing Networks

**1. Dangling:** To disconnect an activity before the completion of all activities in a network diagram is known as dangling. As shown in the figure activities (5 – 10) and (6 – 7) are not the last activities in the network. So the diagram is wrong and indicates the error of dangling.

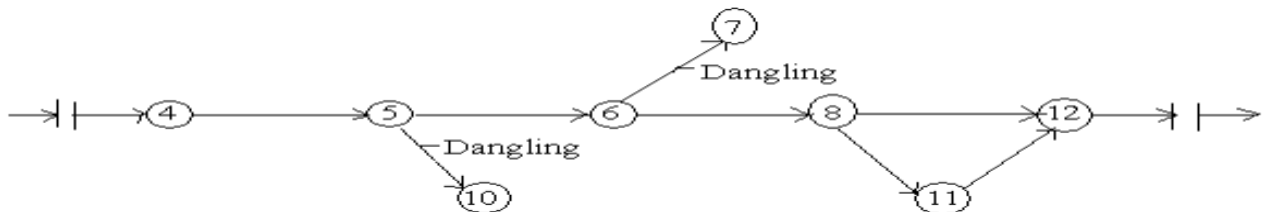

**2. Looping or Cycling:** Looping error is also known as cycling error in a network diagram. Drawing an endless loop in a network is known as error of looping as shown in the following figure.

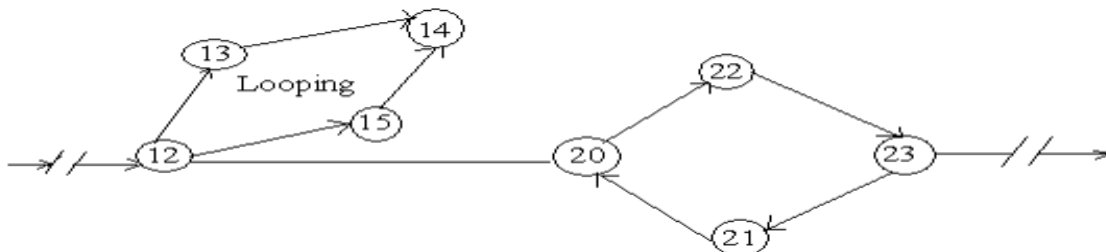

# Management Science

---

3. Redundancy: Unnecessarily inserting the dummy activity in network logic is known as the error of redundancy as shown in the following diagram

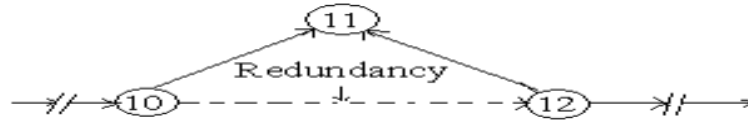

**Program Evaluation Review Technique (PERT):** It is used to plan and identify the time taken to complete a particular activity in a project. Charts created via PERT provide a graphical representation of each task of a project's timeline.

**Critical Path Method (CPM):** It is a project modeling technique that is used for scheduling project activities. It simply finds the maximum time required to complete a specific task. A CPM model includes the following:

- List of all activities involved in the project.
- Dependence of each activity with one another.
- Estimated time required to complete each activity.

Advantages and Disadvantages PERT/CPM:

**Advantages:**

1. A PERT/CPM chart explicitly defines and makes visible dependencies (precedence relationships) between the elements
2. PERT/CPM facilitates identification of the critical path and makes this visible,
3. PERT/CPM facilitates identification of early start, late start, and slack for each Activity
4. PERT/CPM provides for potentially reduced project duration due to better understanding of dependencies leading to improved overlapping of activities and tasks where feasible.

**PERT/CPM disadvantages:**

1. There can be potentially hundreds or thousands of activities and Individual dependency relationships.

2. The network charts tend to be large and unwieldy requiring several pages to print and requiring special size paper.
3. The lack of a timeframe on most PERT/CPM charts makes it harder to show status although colors can help (e.g., specific color for completed nodes).
4. When the PERT/CPM charts become unwieldy, they are no longer used to manage the project.

## Critical Path in Network Analysis

### Basic Scheduling Computations

The notations used are

$(i, j)$  = Activity with tail event  $i$  and head event  $j$

$E_i$  = Earliest occurrence time of event  $i$

$L_j$  = Latest allowable occurrence time of event  $j$

$D_{ij}$  = Estimated completion time of activity  $(i, j)$

$(Es)_{ij}$  = Earliest starting time of activity  $(i, j)$

$(Ef)_{ij}$  = Earliest finishing time of activity  $(i, j)$

$(Ls)_{ij}$  = Latest starting time of activity  $(i, j)$

$(Lf)_{ij}$  = Latest finishing time of activity  $(i, j)$

The procedure is as follows

#### **1. Determination of Earliest time ( $E_j$ ): Forward Pass computation**

- **Step 1**

The computation begins from the start node and move towards the end node. For easiness, the forward pass computation starts by assuming the earliest occurrence time of zero for the initial project event.

- **Step 2**

- i. Earliest starting time of activity (i, j) is the earliest event time of the tail end event i.e.  $(Es)_{ij} = E_i$
- ii. Earliest finish time of activity (i, j) is the earliest starting time + the activity time i.e.  $(Ef)_{ij} = (Es)_{ij} + D_{ij}$  or  $(Ef)_{ij} = E_i + D_{ij}$
- iii. Earliest event time for event j is the maximum of the earliest finish times of all activities ending in to that event i.e.  $E_j = \max [(Ef)_{ij}]$  for all immediate predecessor of (i, j) or  $E_j = \max [E_i + D_{ij}]$

## 2. Backward Pass computation (for latest allowable time)

- **Step 1**

For ending event assume  $E = L$ . Remember that all E's have been computed by forward pass computations.

- **Step 2**

Latest finish time for activity (i, j) is equal to the latest event time of event j i.e.  $(Lf)_{ij} = L_j$

- **Step 3**

Latest starting time of activity (i, j) = the latest completion time of (i, j) – the activity time or  $(Ls)_{ij} = (Lf)_{ij} - D_{ij}$  or  $(Ls)_{ij} = L_j - D_{ij}$

- **Step 4**

Latest event time for event 'i' is the minimum of the latest start time of all activities originating from that event i.e.  $L_i = \min [(Ls)_{ij}]$  for all immediate successor of (i, j) =  $\min [(Lf)_{ij} - D_{ij}] = \min [L_j - D_{ij}]$

## 3. Determination of floats and slack times

- **Total float** – The amount of time by which the completion of an activity could be delayed beyond the earliest expected completion time without affecting the overall project duration time.

Mathematically

$$(Tf)_{ij} = (\text{Latest start} - \text{Earliest start}) \text{ for activity } (i - j)$$

$$(Tf)_{ij} = (Ls)_{ij} - (Es)_{ij} \text{ or } (Tf)_{ij} = (L_j - D_{ij}) - E_i$$

- **Free float** – The time by which the completion of an activity can be delayed beyond the earliest finish time without affecting the earliest start of a subsequent activity.

Mathematically

$$(Ff)_{ij} = (\text{Earliest time for event } j - \text{Earliest time for event } i) - \text{Activity time for } (i, j)$$

$$(Ff)_{ij} = (E_j - E_i) - D_{ij}$$

- **Independent float** – The amount of time by which the start of an activity can be delayed without effecting the earliest start time of any immediately following activities, assuming that the preceding activity has finished at its latest finish time.

Mathematically

$$(If)_{ij} = (E_j - L_i) - D_{ij}$$

The negative independent float is always taken as zero.

- **Event slack** - It is defined as the difference between the latest event and earliest event times.

Mathematically

$$\text{Head event slack} = L_j - E_j, \text{ Tail event slack} = L_i - E_i$$

## 4. Determination of critical path

- **Critical event** – The events with zero slack times are called critical events. In other words the event  $i$  is said to be critical if  $E_i = L_i$
- **Critical activity** – The activities with zero total float are known as critical activities. In other words an activity is said to be critical if a delay in its start will cause a further delay in the completion date of the entire project.
- **Critical path** – The sequence of critical activities in a network is called critical path. The critical path is the longest path in the network from the starting event to ending event and defines the minimum time required to complete the project.

# Management Science

---

**Project Evaluation and Review Technique (PERT):** The main objective in the analysis through PERT is to find out the completion for a particular event within specified date. The PERT approach takes into account the uncertainties. The three time values are associated with each activity

1. **Optimistic time** – It is the shortest possible time in which the activity can be finished. It assumes that everything goes very well. This is denoted by  $t_0$ .
2. **Most likely time** – It is the estimate of the normal time the activity would take. This assumes normal delays. If a graph is plotted in the time of completion and the frequency of completion in that time period, then most likely time will represent the highest frequency of occurrence. This is denoted by  $t_m$ .
3. **Pessimistic time** – It represents the longest time the activity could take if everything goes wrong. As in optimistic estimate, this value may be such that only one in hundred or one in twenty will take time longer than this value. This is denoted by  $t_p$ .

In PERT calculation, all values are used to obtain the percent expected value.

1. **Expected time** – It is the average time an activity will take if it were to be repeated on large number of times and is based on the assumption that the activity time follows Beta distribution, this is given by  $t_e = (t_0 + 4 t_m + t_p) / 6$

The **variance** for the activity is given by :  $\sigma^2 = [(t_p - t_0) / 6]^2$

## PROJECT COST ANALYSIS

A project cost analysis is a process that professionals can use to determine the value of a project's costs and benefits, which highlights if a project is feasible. It begins with a company determining a set price of revenue they want to generate from the project, then creating a list of all the project expenses, combined with the benefits that a company receives from the project once it's finished.

# Management Science

---

After the list, the company adds together the total value of their costs and benefits, then subtracts the total cost from the benefits, which shows if a project is profitable and meets their set price. For example, if a project cost analysis shows that a project's materials cost is higher than the profit that a company makes off the project, then they may decide against pursuing the project.

**1. Determine a set price:** Before starting your project cost analysis, have a set budget that helps you decide if you want to pursue a project or not. For example, you may decide to only pursue a project if the project cost analysis shows that it will bring in \$30,000 in revenue to your company.

**2. List all associated costs:** To begin your project cost analysis, list all elements that have costs associated with the project. Try including any unexpected costs, like extra materials you may need or extra equipment that's prone to breakage.

**3. Convert cost to monetary value :** Next, assign a monetary value to each element that you listed. To do this, you can communicate with suppliers for your project to understand the cost of materials and equipment, and communicate with management about overhead costs, like labor, rent and taxes.

**4. List estimated benefits:** After listing your costs, make a list of the benefits that you estimate the project to create. To do this, look at the goals of your project and who can benefit from your project.

**5. Convert benefits to monetary value:** Try to assign a monetary value to each benefit, though keep in mind that your estimations may be off slightly since there are several factors that predict the outcome of a project. To do this, analyze previous projects similar to the project you're currently completing to see how their estimated benefits compared to the actual benefits.

**6. Add costs together:** Add the total value of your project costs together.



# Management Science

---

**7. Perform subtraction:** To complete your project cost analysis, perform the necessary subtraction that shows your project's overall profitability. Subtract the project's total costs from the estimated benefits.

**8. Compare to your decided price:** Once you have completed your project cost analysis, compare it to your set price to determine if the project is worth pursuing or not.

## Benefits of project cost analysis

Here are several benefits from completing a project cost analysis:

- **Minimizes financial risk:** Project cost analysis shows if there's a possibility of the project exceeding the budget and having low profitability.
- **Determines project feasibility:** Using project cost analysis shows if a project is feasible according to your budget and the project's profitability.
- **Helps prioritize projects:** If you do a project cost analysis for several projects, you can determine which projects to pursue based on which projects show the highest profitability and lowest financial risk.
- **Get support from stakeholders:** If a project cost analysis shows that a project is feasible and profitable, it may help you to earn support from stakeholders.

## Project Crashing

Project crashing involves shortening the expected time taken for a project. This is primarily done by adding more resources to it. You may find diverse ways to add resources to a project depending on what is causing the delay or taking a lot of time. This needs to be done within the constraints of budget and quality, and must be approved and supported by important stakeholders.

## Reasons for Project Crashing

- The reason for the need to crash a project need not be about something going wrong with the project itself.

## Management Science

---

- Sometimes it is also an external factor that changes the estimated delivery time or brings a need for faster completion.
- If there is a **heavy penalty** for failing to meet a project completion deadline, then the increased cost of crashing could be justified to an extent.
- **A bonus for faster completion** can also similarly be a reason for crashing a project.
- If there is an external change where a competitor is working on a similar project, the cost of not speeding up the project would lead to the loss of a **competitive edge**.
- In case there is an activity that **delays a host of other activities**, crashing that activity could bring benefits across the project.
- if there are **new people or an idle workforce** available that was not previously anticipated, the project plan can be changed to use this additional workforce to bring down the time for compl

# Management Science

---

## UNIT – V - CONTEMPORARY ISSUES IN MANAGEMENT

### A. Management Information System

Management Information System is a system designed in order to study people, technology, organizations and the relationships among them. MIS provides selected decision-oriented information needed by management to plan and evaluate the activities of the organization. Needless to say, the Information System is one of the most promising fields today. Read this blog further to know more about the scope of MIS and the nature of management.

#### Objectives of MIS

- **Capturing Data** – Capturing contextual data, or operational information that will contribute in decision making from various internal and external sources of organization.
- **Processing Data** – The captured data is processed into information needed for planning, organizing, coordinating, directing and controlling functionalities at strategic, tactical and operational level. Processing data means –
  - making calculations with the data
  - sorting data
  - classifying data and
  - summarizing data
- **Information Storage** – Information or processed data need to be stored for future use.
- **Information Retrieval** – The system should be able to retrieve this information from the storage as and when required by various users.
- **Information Propagation** – Information or the finished product of the MIS should be circulated to its users periodically using the organizational network.

#### Nature of MIS

- MIS is utilized by every level of a management.
- It clarifies and focuses on the strategic goals and objectives for the management.

# Management Science

---

- MIS provides an effective system to analyze costs and revenues and further reviews effectively and efficiently to bring a balanced in finances and costs.
- MIS is maintained either through manual systems or automated systems or a combination of both.
- It also plays a incremental role in identifying, locating, measuring, tackling and limiting risks.
- It lays down a framework of rules and regulations for the management to bring a clear and concise communication between employees.

## Scope of MIS

MIS involves performing a number of task simultaneously such as-

- Processing data
- Initiating transactions
- Responding to inquiries
- Producing reports and its summaries
- Manage the data created within the structure of a particular business

## Characteristics of MIS

- It should be based on a long-term planning.
- It should provide a holistic view of the dynamics and the structure of the organization.
- It should work as a complete and comprehensive system covering all interconnecting sub-systems within the organization.
- It should be planned in a top-down way, as the decision makers or the management should actively take part and provide clear direction at the development stage of the MIS.
- It should be based on need of strategic, operational and tactical information of managers of an organization.
- It should also take care of exceptional situations by reporting such situations.

# Management Science

---

**Three Components of MIS:** The three components of MIS provide a more complete and focused definition, where **System** suggests integration and holistic view, **Information** stands for processed data, and **Management** is the ultimate user, the decision makers. Management information system can thus be analyzed as follows –

**Management:** Management covers the planning, control, and administration of the operations of a concern. The top management handles planning; the middle management concentrates on controlling; and the lower management is concerned with actual administration.

**Information:** Information, in MIS, means the processed data that helps the management in planning, controlling and operations. Data means all the facts arising out of the operations of the concern. Data is processed i.e. recorded, summarized, compared and finally presented to the management in the form of MIS report.

**System:** Data is processed into information with the help of a system. A system is made up of inputs, processing, output and feedback or control.

Thus MIS means a system for processing data in order to give proper information to the management for performing its functions.

## **Benefits of MIS**

- increased **customer satisfaction**
- Improved quantity and **quality of information**
- Improved quality and **quantity management decisions**
- Improved **responsiveness number of the competitor's condition**
- Improved **operational efficiency and flexibility**
- Improved **quality of internal and external communications**
- Improved **quality of planning**
- Improved **quality control and supervision**

---

# Management Science

---

## **B. Enterprise Resource Planning**

ERP is an integrated, real-time, cross-functional enterprise application, an enterprise-wide transaction framework that supports all the internal business processes of a company. It supports all core business processes such as sales order processing, inventory management and control, production and distribution planning, and finance.



### **Scope of ERP**

- **Finance** – Financial accounting, Managerial accounting, treasury management, asset management, budget control, costing, and enterprise control.
- **Logistics** – Production planning, material management, plant maintenance, project management, events management, etc.
- **Human resource** – Personnel management, training and development, etc.

# Management Science

---

- **Supply Chain** – Inventory control, purchase and order control, supplier scheduling, planning, etc.
- **Work flow** – Integrate the entire organization with the flexible assignment of tasks and responsibility to locations, position, jobs, etc.

## **Advantages of ERP**

- Reduction of lead time
- Reduction of cycle time
- Better customer satisfaction
- Increased flexibility, quality, and efficiency
- Improved information accuracy and decision making capability
- Onetime shipment
- Improved resource utilization
- Improve supplier performance
- Reduced quality costs
- Quick decision-making
- Forecasting and optimization
- Better transparency

## **Disadvantage of ERP**

- Expense and time in implementation
- Difficulty in integration with other system
- Risk of implementation failure
- Difficulty in implementation change
- Risk in using one vendor

## Features of ERP

The following diagram illustrates the features of ERP –

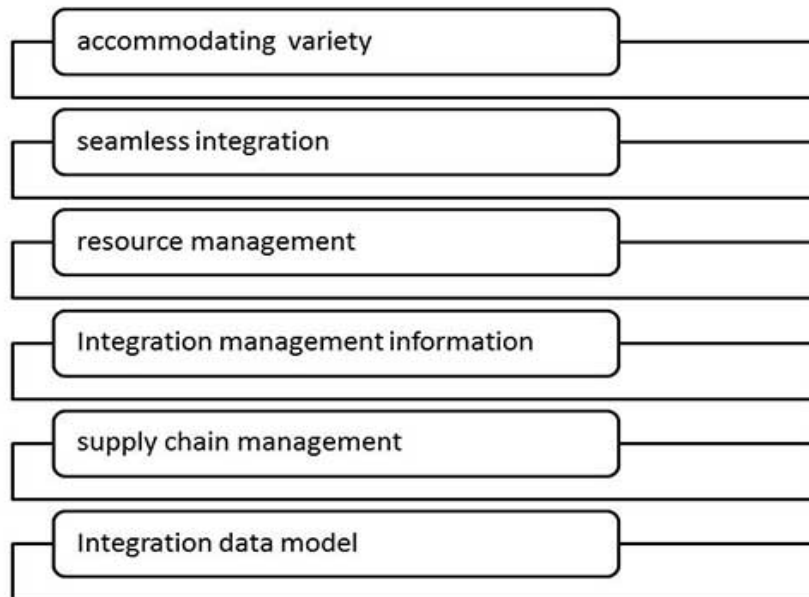

## C. Customer Relationship Management

CRM is an enterprise application module that manages a company's interactions with current and future customers by organizing and coordinating, sales and marketing, and providing better Customer services along with technical support.

### **CRM important for Marketing**

- 1. Customer Experience:** Improving your customer relationships is important to improve sales. A happy customer is the one who keeps returning to you for more and this helps your business grow. But what makes a customer come back to you to make more purchases? The answer is, customer experience.
- 2. Increases customer loyalty:** Customer loyalty is highly important in a business it may take some time to build it but once you gain loyal customers your business will bloom. Earning a customer's loyalty makes it easier to communicate with them.
- 3. Customer engagement:** Consumer experience, customer loyalty and customer engagement combines are key elements in making branding initiatives. With CRM



# Management Science

---

you can implement your brand and your products/services deeper into the lives of your customers

## **Functions of CRM:**

Customer Relationship Management performs wide range of functions for the business. Some of these functions are discussed below:

1. **Acquiring & Storing Information:** It is one of the most important function performed by CRM. It collects & stores information about target customers from the market. The information collected is stored on databases centrally.
2. **Customer Management:** Management of customers is important task performed by CRM. It divides & groups all customers into different groups as per their behavior & nature. Segmenting of customers helps in serving them better.
3. **Management of Marketing Policies:** It is concerned with personalizing of marketing programs of businesses. It aims at designing marketing strategies as per the needs of different customers. Attempts are made to attract more & more customers.
4. **Increase Sales:** Customer Relationship Management aims to increase sales & profit of the business. It helps in increasing business with existing customers as well as new customers. CRM focuses on Cross-selling & Up-selling techniques to increase its sales with existing customers.
5. **Proper Communication Network:** Providing good customer support is an important function performed by CRM. It aims at providing fast & best customer support. A proper channel is developed to handle all the problems & queries of customers.
6. **Cost Controlling:** Cost-saving is one of great challenge in front of any business. Business is successful if it is able to provide better quality products at less cost. Customer Relationship Management reduces the expenses of business by minimizing the paperwork involved.
7. **Improve Quality:** Customer Relationship Management aims at increasing the product quality of businesses. The information acquired through the CRM technique helps in better

# Management Science

---

understanding the needs of customers. This information is then used for customizing the offerings of businesses to customers.

## **Advantages of CRM**

- Provides better customer service and increases customer revenues.
- Discovers new customers.
- Cross-sells and up-sells products more effectively.
- Helps sales staff to close deals faster.
- Makes call centers more efficient.
- Simplifies marketing and sales processes.

## **Disadvantages of CRM**

- Sometimes record loss is a major problem.
- Overhead costs.

## **D. TOTAL QUALITY MANAGEMENT(TQM)**

Quality is one of the initial measuring standards that any customer or purchaser analyses about a product. Therefore, any manufacturing company has the essential role of maintaining and managing the quality of the product to enhance and grow the company's reputation. Therefore, a management system termed TQM, which stands for Total Quality Management, is considered for maintaining the quality of the products and enhancing the quality standards as per the market's needs and desires.

Total Quality Management focuses on determining the flaws and defects in a product during the manufacturing time to eliminate these defects without any loss. Many large-scale infrastructures are extensively adopting TQM to maintain and enhance the quality standards of their product.

## **Principles of Total Quality Management**

1. **Customer-Focused:** It is customer-focused. All products must fulfill the quality standards to satisfy the customers' needs, desires, and requirements. The basic belief of total quality management is the customer's complete satisfaction.

## Management Science

---

2. **Involvement of the Employee:** All employees' complete involvement is essential for properly managing quality standards for the product. Each employee taking part effectively and efficiently in the quality analysis of the product will lead to a high-quality outcome.
3. **Process-Centered:** It is considered process-centered as it focuses strictly on the procedure of quality management. The product taken into consideration needs to eliminate any flaws at the initial stage. Eliminating the flaws in the initial stage could prove to be quite beneficial for the company as it will be cost-effective.
4. **Strategic Approach:** It is a kind of management system that relies on strategic, innovative, and new quality measurement ideas for analyzing the quality standards of a product to meet the requirements and the needs of the growing market. The involvement of new strategies, high-quality tools, and new analysis structures must be considered a strategic approach to improving the quality and reputation of the company.
5. **Continuous Improvement:** The basic principle of total quality management is the continuous improvement of the product. Quality standards must be increased as per the growing market. As the market grows, the customers' needs are growing according to it. Therefore, a continuous and constant rate of improvement is necessary.
6. **Decision Making:** Decision making is one of the most crucial steps in any management system. Therefore, the supervisor or the leader must be appointed who has great decision-making skills. The involvement of such a leader will provide perfect guidance to the employees, which will improve the overall quality standards of the product.
7. **Communication:** There must be proper communication between the employees in a company. The proper communication will set up an enhanced environment for analysis and the quality check of the product. Without proper communication in the company will lead to a great loss.

## **Benefits of Total Quality Management**

- The total quality management is in the quality check during the manufacturing of the products, making it a cost-effective procedure because it eliminates the flaws during the initial stage.
- The quality check prevents the rejection of any products from the customer side, which could be a great drawback for the company.
- TQM leads to improved profit range as well as efficiency of the company.
- It encourages the employee to take a more effective part in the development and growth of the company.
- The product that went under the analysis of TQM provides higher profitability and a higher customer satisfaction rate.
- It plays a vital role in improving the productivity of the outcome products.
- With the increase in the demand for the product, there will be an increase in the employment rate.
- Enhances the managing skills of the leader or advisor, that is, managing analysis of the total quality management.

## **Beliefs about Total Quality Management**

When it comes to total quality management, several beliefs are considered beneficial for the company. Some of these beliefs are:

1. Everyone is considered to be the owner and the customer of the company.
2. The quality improvement must be constant and in a continuous phase.
3. The measure of quality should determine the satisfaction of an owner or a customer.
4. The key role of quality improvement depends upon the analysis of the product and the services provided by the company.

# Management Science

---

5. It is believed that quality management will provide satisfactory quality only if the employees are involved with dedication and improved ideas and innovations.
6. Quality improvement is seen when the leader, supervisor, or the head of the quality management plays a vital role and puts effort into the quality analysis.
7. To maintain and improve the reputation of a company or business, it is very efficient for continuous improvement and enhancing the quality of the products.
8. Along with the improved quality of the product, it is also believed to enhance an organization's service to enhance the growth rate of the infrastructure.

## E. SIX- SIGMA

### **History**

Six - Sigma actually has its roots in a 19th Century mathematical theory, but found its way into today's mainstream business world through the efforts of an engineer at Motorola in the 1980s. Now heralded as one of the foremost methodological practices for improving customer satisfaction and improving business processes, Six Sigma has been refined and perfected over the years into what we see today.

### **Concept**

Six-Sigma is a methodology that helps improve business processes by using statistical analysis. It is a data-driven and highly disciplined methodology and approach that ensures the elimination of defects in any type of business or organizational process.

In order to achieve Six Sigma, organizational processes need to keep their defects to a maximum of 3.4 per million (99.99966%) opportunities. A Six Sigma defect can be defined as anything that is outside of client specifications. Its objective is to minimize the variability in business and manufacturing processes. One of the salient highlights is the ability to create a focus on achieving quantifiable and measurable financial returns from any six sigma project.

Developed by Motorola in 1986, Six Sigma is basically a set of tools and techniques that enable process improvement.

## Methodologies of Six-Sigma

There are two major methodologies used within Six Sigma, both of which are composed of five sections, according to the 2005 book “JURAN Institute Six Sigma Breakthrough and Beyond” by Joseph A. De Feo and William Barnard.

**1. DMAIC:** The DMAIC method is used primarily for improving existing business processes.

The letters stand for:

- **Define** the problem and the project goals
- **Measure** in detail the various aspects of the current process
- **Analyze** data to, among other things, find the root defects in a process
- **Improve** the process
- **Control** how the process is done in the future

**2. DMADV:** The DMADV method is typically used to create new processes and new products or services. The letters stand for:

- **Define** the project goals
- **Measure** critical components of the process and the product capabilities
- **Analyze** the data and develop various designs for the process, eventually picking the best one
- **Design** and test details of the process
- **Verify** the design by running simulations and a pilot program, and then handing over the process to the client

## Benefits of Six-Sigma

**1. Reduce Operational Costs:** For most of the companies operating globally, operational cost & risks are significant factors. These factors contribute to low profits or even losses. Some risks cannot be eliminated, and operational cost is always omnipresent. Six-Sigma methodology can provide a road map that can drastically reduce an organization’s exposure to risks.

**2. Improve Efficiency or Timeliness:** Six Sigma projects help improve the efficiency of the overall process. Moreover; improving the timelines in delivering the process output or

improving the on-time delivery of products or service every time can be the focus areas for Six Sigma projects.

**3. Improve Accuracy, Controls, and Policy Compliance:** Six Sigma projects help improve accuracy by reducing Defects-Per-Million-Opportunities (DPMO) across the value stream in the process. The word ‘opportunity’ means the chance to commit an error. DPMO is a probabilistic measure of error rate or capability of a business or manufacturing process. This measure takes into account both actual defects & number of probable defects in every opportunity.

**4. Improve Customer Service:** The image of the company is created in large part by its interaction with customers. Any company would want this interaction to be as stable as possible. The reason being disappointed customers is vocal critics. Six Sigma projects can help identify the number of variations customers are experiencing, what is driving that variation, and ultimately, how the number of dis-satisfied customers can be minimized.

**5. Improve Cash Flow:** Six Sigma projects can also be targeted towards improving DSO i.e. Days Sales Outstanding in the business. If DSO improves, then cash flow improves as well. The higher the DSO, the lesser the ability of the company to convert credit sales into cash. Six Sigma projects can be aimed at reducing variation in Invoicing Process, Accounts Payable Process, Accounts Receivable process, Inventory Management Process, etc

### **F. SUPPLY CHAIN MANAGEMENT**

Supply Chain Management can be defined as the management of flow of products and services, which begins from the origin of products and ends at the product’s consumption. It also comprises movement and storage of raw materials that are involved in work in progress, inventory and fully furnished goods.

The main objective of supply chain management is to monitor and relate production, distribution, and shipment of products and services. This can be done by companies with a very good and tight hold over internal inventories, production, distribution, internal productions and sales.

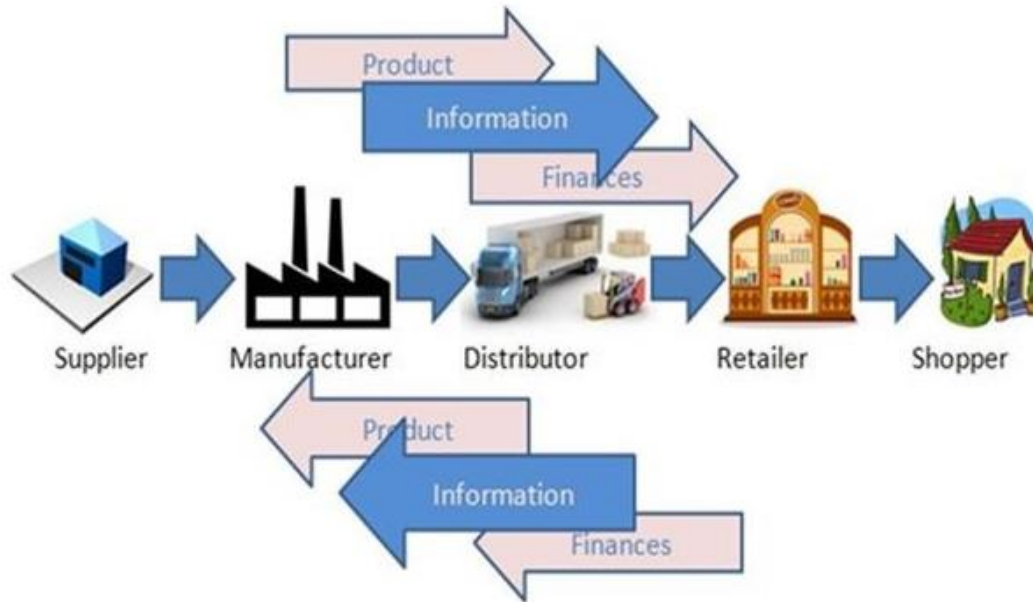

In the above figure, we can see the flow of goods, services and information from the producer to the consumer. The picture depicts the movement of a product from the producer to the manufacturer, who forwards it to the distributor for shipment. The distributor in turn ships it to the wholesaler or retailer, who further distributes the products to various shops from where the customers can easily get the product.

Supply chain management basically merges the supply and demand management. It uses different strategies and approaches to view the entire chain and work efficiently at each and every step involved in the chain. Every unit that participates in the process must aim to minimize the costs and help the companies to improve their long term performance, while also creating value for its stakeholders and customers. This process can also minimize the rates by eradicating the unnecessary expenses, movements and handling.

## **Benefits of supply chain management**

The **key benefits of supply chain management** are as follows –

- Develops better customer relationship and service.
- Creates better delivery mechanisms for products and services in demand with minimum delay.



# Management Science

---

- Improvises productivity and business functions.
- Minimizes warehouse and transportation costs.
- Minimizes direct and indirect costs.
- Assists in achieving shipping of right products to the right place at the right time.
- Enhances inventory management, supporting the successful execution of just-in-time stock models.
- Assists companies in adapting to the challenges of globalization, economic upheaval, expanding consumer expectations, and related differences.
- Assists companies in minimizing waste, driving out costs, and achieving efficiencies throughout the supply chain process.

## **Supply Chain Management - Goals**

- Supply chain partners work collaboratively at different levels to maximize resource productivity, construct standardized processes, remove duplicate efforts and minimize inventory levels.
- Minimization of supply chain expenses is very essential, especially when there are economic uncertainties in companies regarding their wish to conserve capital.
- Cost efficient and cheap products are necessary, but supply chain managers need to concentrate on value creation for their customers.
- Exceeding the customers' expectations on a regular basis is the best way to satisfy them.
- Increased expectations of clients for higher product variety, customized goods, off-season availability of inventory and rapid fulfillment at a cost comparable to in-store offerings should be matched.

---

# Management Science

---

- To meet consumer expectations, merchants need to leverage inventory as a shared resource and utilize the distributed order management technology to complete orders from the optimal node in the supply chain.

## Supply chain management - Process

Supply chain management is a process used by companies to ensure that their supply chain is efficient and cost-effective. A supply chain is the collection of steps that a company takes to transform raw materials into a final product. The five basic components of supply chain management are discussed below –

**1. Plan:** The initial stage of the supply chain process is the planning stage. We need to develop a plan or strategy in order to address how the products and services will satisfy the demands and necessities of the customers. In this stage, the planning should mainly focus on designing a strategy that yields maximum profit.



**2. Develop (Source):** After planning, the next step involves developing or sourcing. In this stage, we mainly concentrate on building a strong relationship with suppliers of the raw materials required for production. This involves not only identifying dependable suppliers

# Management Science

---

but also determining different planning methods for shipping, delivery, and payment of the product.

**3. Make:** The third step in the supply chain management process is the manufacturing or making of products that were demanded by the customer. In this stage, the products are designed, produced, tested, packaged, and synchronized for delivery. Here, the task of the supply chain manager is to schedule all the activities required for manufacturing, testing, packaging and preparation for delivery.

**4. Deliver:** The fourth stage is the delivery stage. Here the products are delivered to the customer at the destined location by the supplier. This stage is basically the logistics phase, where customer orders are accepted and delivery of the goods is planned. The delivery stage is often referred as logistics, where firms collaborate for the receipt of orders from customers, establish a network of warehouses, pick carriers to deliver products to customers and set up an invoicing system to receive payments.

**5. Return:** The last and final stage of supply chain management is referred as the return. In the stage, defective or damaged goods are returned to the supplier by the customer. Here, the companies need to deal with customer queries and respond to their complaints etc. This stage often tends to be a problematic section of the supply chain for many companies. The planners of supply chain need to discover a responsive and flexible network for accepting damaged, defective and extra products back from their customers and facilitating the return process for customers who have issues with delivered products.

## **G. PERFORMANCE MANAGEMENT**

Performance management can be defined as the development of individuals with competence and commitment, working towards the achievement of shared meaningful objectives within an organization which supports and encourages their achievement.

**According to Michael Armstrong and Angela Baron** – *‘Performance management is a process which contributes to the effective management of individual and teams in order to achieve high levels of organizational performance.’*

# Management Science

---

## Aim of Performance Management

The main aim of performance management is its intension to create and establish a high performance culture with each individual and teams to take the responsibility for the ever improving business processes and for their own skills and contributions within a framework provided by effective leadership. Hence, focusing people on doing the right things through achieving goal clarity.

1. Empowering, motivating, encouraging and rewarding employees through different ways used by the management of the organization, through which the employees would give all their efforts to do best.
2. Improving and maximizing the individuals and teams potentials for the benefits of themselves and the benefits of the organization. This can be done and attained by putting focus on organization objectives achievement.
3. To enable managers of organizations to attain a high achieving organization through the use of good management policies that enable them to be in control of the performance of their employees.
4. To enable all individuals within an organization to be fully aware of what they need to achieve in performing their duties and what is expected by the management from their performance in fulfilling their duties

## Features of Performance Management:

1. **Clarity of organizational goals:** the managers need to clearly and precisely lay down the organizational goals, objectives and ensure that these are well informed to the managers and other employees and make them to realize what the organization expects from them. The organizational goals need to be translated into individual, team and departmental/divisional goals.
2. **Evaluation:** the individual, team, department/ divisional performance needs to be evaluated on continuous basis. The organization should develop an evaluation system and process, which is designed and developed on scientific lines.

## Management Science

---

3. **Cooperation but not control:** the managers should nurture the practice of getting work done through the system of obtaining managers consensus rather than through control or coercion.
4. **Self-management teams:** the management need to encourage the individual and teams for self-management of their performance. This procedure creates in the managers a sense of responsibility and develops a spirit to work with commitment and evaluate his or her strengths and weaknesses from time to time and plan for reducing the performance gaps.
5. **Leadership development:** the managers need to identify such of the managers who have leadership potential and apart from sincerity and honesty to ensure better and effective two-way communication between the managers and the managers.
6. **System of feedback:** the organization must have a foolproof feedback system of managers/individuals/teams/departments performance. It should be monitor continuously and generate feedback loops for better performance management

### **Principles of Performance Management:**

1. **Transparency:** Decisions relating to performance improvement and measurement such as planning, work allocation, guidance and counseling and monitoring, performance review etc., should be effectively communicated to the managers and other members in the organization.
2. **Employee development and empowerment:** Effective participation of employees or managers (individuals and teams) in the decision making process and treating them as partners in the enterprise. Recognizing employees or managers of their merit, talent and capabilities, rewarding and giving more authority and responsibility etc., come under the umbrella this principle.
3. **Values:** a fair treatment and ensuring due satisfaction to the stakeholders of the organization, empathy and trust and treating people as human beings rather than as mere employees form the basic foundation, apart from others.

# Management Science

---

4. **Congenial work environment:** the management needs to create a conducive and congenial work culture and climate that would help people to share their experience knowledge and information to fulfill the manager's aspirations and achieve organizational goals. The managers or employees should be well informed about the organizational mission, objectives, values and the framework for managing and developing individuals and teams for better performance.
5. **External environment:** effective and contextual management of external environment to overcome the obstacles and impediments in the way of effective managerial performance

**Performance Management Process:** . Performance management is a process management which consists of the following activities:

1. **Plan** – decide what to do and how to do it.
2. **Act** – carry out the work needed to implement the plan.
3. **Monitor** – carry out continuous checks on what is being done and measure outcomes in order to assess progress in implementing the plan.
4. **Review** – consider what has been achieved and, in the light of this, establish what more needs to be done and any corrective action required if performance is not in line with the plan.

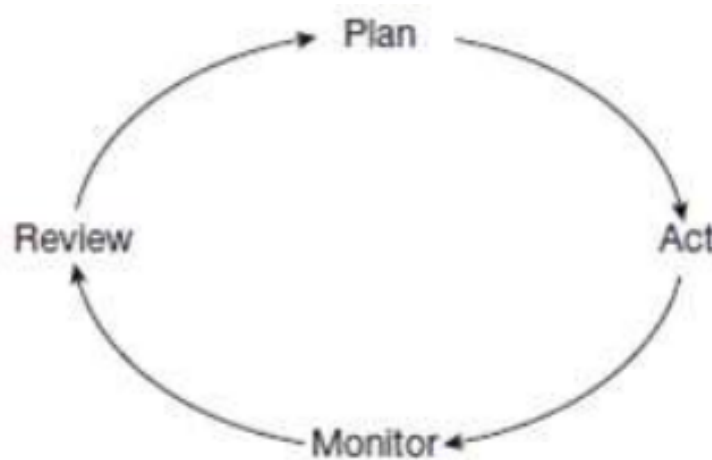

This sequence of activities can be expressed as a continuous cycle as shown in the following figure:

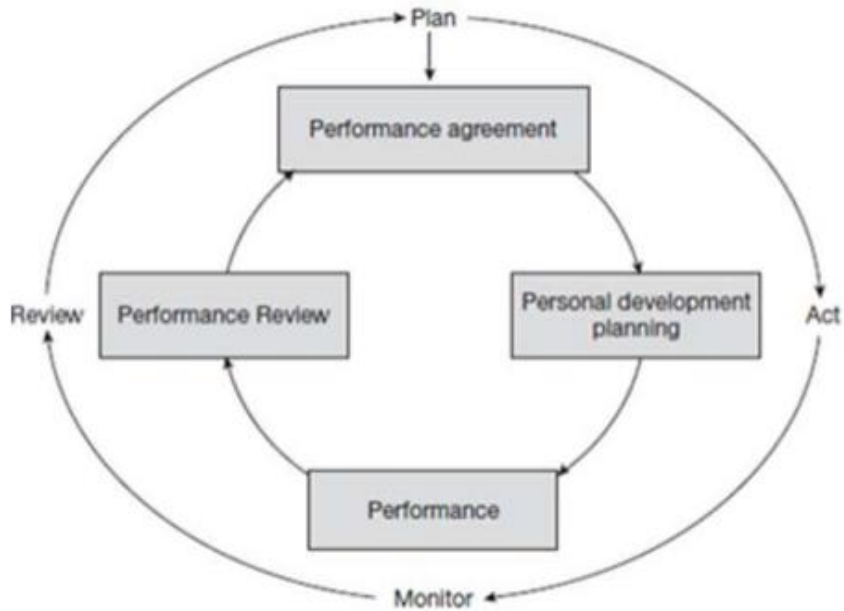

## H. Business Process Outsourcing (BPO)

Business Process Outsourcing (BPO) is a form of outsourcing where one organization delegates one or more business processes to another company. The business functions that are most commonly outsourced are customer support, back-office, payroll, HR activities, data entry services, market research, etc.

### Categories of Business Process Outsourcing

When organizations refer to BPO companies, they often focus on the type of business functions and work that they are going to outsource. Depending on the company's specific needs, BPO services are divided into two categories:

**1. Back Office Outsourcing:** Back Office Outsourcing is a form of outsourcing that deals primarily with in-house business activities that include data entry, internet research, data collection, data analysis, order processing, payment processing, quality assurance, information technology services, billing, etc.

**2. Front Office Outsourcing:** Front office BPO refers to outsourcing customer-facing tasks such as marketing, sales, tech support, customer services, grievances redressed, etc.

## Types of BPO

Based on the geographical location of the vendor, the BPO industry is divided into 3 types. A company can achieve absolute process optimization by combining these 3 categories.

**1. Offshore Outsourcing:** When an organization hires a service provider located in a different country for fulfilling certain work requirements, then it is known as offshore outsourcing. *For instance:* a US-based agency outsources its business functions to a company in India.

**2. Nearshore Outsourcing:** Nearshore outsourcing happens when a company outsources its business functions to a company in a neighboring country. *An example* of this is a Canadian company that outsources its selected business functions to a US company.

**3. Onshore Outsourcing:** When a business outsources its non-core functions to a company located in the same country, then it is known as onshore outsourcing. *For example* – When a US-based agency hires an outsourcing firm in the USA.

## Choose a BPO Service Provider

It is the utmost important decision for a company to pick the right outsourcing partner. Transferring in-house non-core business activities to a BPO company requires change management as it creates an impact on the employees, business operations, workflow practices as a whole. If you are messing up here, finding a new company will be both expensive and time-consuming. The decision-making of outsourcing involves the following process:

**1. Define your Requirements:** It is very important to have a clear understanding of the business processes that need to be outsourced. Without specifications, it will be difficult to find the perfect outsourcing partner. Moreover, the partner company should understand the exact job entails and the project specifications.

**2. Narrow down your selection criteria:** The most crucial step of picking the right vendor is to decide on the selection criteria while evaluating them based on it. The criteria that can be used while selecting your BPO service provider are as follows:



# Management Science

---

- Area of Expertise of the BPO Company
- Services offered by them
- Employee Strength of the firm
- Cost of their services
- List of clienteles

**3. Shortlist Few Outsourcing Agencies:** Based on your evaluation criteria, start short listing few outsourcing agencies. Ideally, the shortlisted companies will be limited to three to five service providers that can be narrowed down further.

**4. Assigning Pilot projects:** Once, the process of short listing has been done, now it is time to delegate pilot projects to each of them. This helps in assessing the firm's ability to execute the tasks that will be given to the firm which will be hired.

**5. Evaluation of the BPO agencies:** This is the most crucial step which helps to select the apt outsourcing agency. Evaluation can be done based on the criteria such as:

- Quality of the Delivered Output
- The adaptability of the sudden updates in the project
- Turnaround time of the project
- Cost of the Services offered

**6. Monitoring the Project Performance:** Starting the project with the outsourcing partner is the first step. The work needs to be monitored closely while ensuring that the outsourcing firm can deliver your project in time.

## **Advantages of Business Process Outsourcing:**

**1. Lowered Costs:** The greatest benefit that organizations are experiencing while using BPO services is cost savings. Typically, in businesses, a large portion of their finances is incurred into manpower. However, it is not possible to perform all businesses within the company. Because it includes the process of hiring, on boarding this is time-consuming as well as expensive.

# Management Science

---

**2. Enhanced Speed and Efficiency:** It is a proven fact that organizations tend to stay in their wheel tracks for a longer time when they are outsourcing their non-critical business processes to the outsourcing partner. In this case, they can successfully manage their business criticalities more efficiently while paying almost negligible attention to the less complicated functions.

**3. Gaining Competitive Advantage:** To be more competitive in the overseas market, it is of utmost importance for agencies to find and continuously improve their expertise and skills on services and products that they are offering. With non-critical processes handled by outsourcing partners, organizations find more room to become more efficient on their products thus tapping more customers in their respective target market.

**4. Greater Flexibility:** Efficient allocation of resources is the key to success for any business. When a company outsources its non-business functions to outsource vendors, it is like that the vendor will spend time and expertise while delivering the project on time. Hence, they can allocate their resources to the core business activities and employees for better performance.

**5. Time Zone Advantage:** With scaling businesses, often companies enter into a foreign market. The most common problem that firms face that has businesses spread across the globe is time zone. If the company is headquartered in Sunnyvale, then it will be difficult to expand their businesses in different countries of Asia and Australia, when you can't have employees available for each time zone of those countries.

## **KNOWLEDGE MANAGEMENT**

Knowledge management is the systematic management of an organization's knowledge assets for creating value and meeting tactical & strategic requirements. It consists of the initiatives, processes, strategies, and systems that sustain and enhance the storage, assessment, sharing, refinement, and creation of knowledge.

Each enterprise should define knowledge management in terms of its own business objectives. Knowledge management is all about applying knowledge in new, previously overburdened or novel situations.

# Management Science

---

**Application Knowledge Management:** Application of Knowledge Management (KM) lie in the below four key areas

- **Globalization of Business** – Organizations today are more universal i.e., they are operating in multiple sites, multilingual, and multicultural in nature.
- **Leaner Organizations** – Organizations are adapting to a lean strategy where they understand customer value and focus on key processes to continuously increase it. The ultimate goal is to provide perfect value to the customer through a perfect value creation process that has zero waste.
- **Corporate Amnesia** – we are freer as a workforce, which creates issues regarding knowledge continuity for the organization and places with continuous learning demands from knowledge worker. We no longer expect to spend our entire work life with the same organization.
- **Technological Advances** – the world is more connected with the advent of websites, smart phones and other latest gadgets. Advancements in technology has not only helped in better connectivity but also changed expectations. Companies are expected to have online presence round the clock providing required information as per the customer needs.

## **Knowledge management process**

Implementing effective knowledge management requires proactive strategies and incorporating multiple new processes. Companies have to uncover the existing knowledge available to them, understand how to spread this information to produce additional value, and plan what this looks like in action.

1. **Discovery:** Every organization has multiple sources of knowledge, from employees to data and records. This could be the education and skill-sets staff bring to the job, the experience and unique expertise they develop on the job, or hard drives of data that can positively affect the business with proper analysis.

# Management Science

---

During the discovery process, organizations must identify all the available sources of knowledge, with a particular emphasis on information that could be easily lost.

This process is simplified by a strong understanding of where and how knowledge flows around the organization.

**2. Collection:** Collecting all the available knowledge and data creates the foundation from which future processes build. Sloppy or incorrect knowledge collection leads to decisions without a complete understanding of the organization and its capabilities.

Companies must audit their existing staff expertise, documentation, and external knowledge sources. A range of tools is available to help, including automated surveys, document scanning, and metadata.



Post-implementation, many organizations redefine internal processes to make capturing institutional knowledge a part of everyday processes. This could be through continual employee feedback systems or more in-depth off-boarding procedures.

**3. Assessment:** This process involves the deep analysis of the knowledge gathered in the previous two steps. Data must be assessed and organized into a structured, searchable, and easily accessible form.

# Management Science

---

Assessment of the gathered knowledge is required to ensure it is accurate, offers value, and is up to date. Then teams can determine how best to share information to improve company performance and give staff the knowledge they need to maximize performance.

**4. Sharing:** The whole point of knowledge management is to give staff the expertise and information they need to do their job to the best of their ability.

Once you have built a detailed and accurate body of knowledge related to your company, you need to plan how it will be share.

## Knowledge management methods

**1. Tutoring & training, communities of practice, and Q&A:** These examples all involve transferring information directly from the knowledge holder to other employees. This could be through in-person tutoring, company-wide training sessions, online chats, and group discussions – or a mix of these options and others. Many companies value building a skills matrix that maps each employee

**2. Documentations, guides, guidelines, FAQ, and tutorials:** Written communications are great for storing and transferring knowledge. With text-based knowledge management, a system to store, categorize and navigate subjects is always available. In many cases, metadata is a great help for this.

**3. Forums, intranets, and collaboration environments:** These online resources spark conversation and bring many knowledge holders into the same place. Threads, sub-forums, and groups can be divided by topic, level of expertise, or any number of other classifications.

**4. Learning and development environments:** Creating an environment where learning is considered an asset will continuously drive employees to educate themselves. Incentivizing them to take advantage of your knowledge management systems will result in up-skilled employees ready to take on leadership roles in your organization.

# Management Science

---

For this to happen, there must be structured and accessible learning and development technology in place that employees can use.

**5. Case studies:** These in-depth studies into particular areas serve as complete guides to a subject. Looking at the actions taken, the results they produce, and any lessons learned are extremely valuable.

**6. Webinars:** These online seminars can be beneficial in widely disseminating ideas throughout teams, branches, or the entire company.

## **BALANCED SCORECARD (BSC)**

A balanced scorecard (BSC) is defined as a management system that provides feedback on both internal business processes and external outcomes to continuously improve strategic performance and results. By bringing together measures around internal processes and external outcomes, a balanced scorecard supports continuous improvement at the level of strategic performance and results.

The balanced scorecard is a strategic management tool that views the organization from different perspectives, usually the following:

- **Financial:** The perspective of your shareholders
- **Customer:** What your customers experience and perceive
- **Business process:** The key processes you use to meet and exceed customer and shareholder requirements
- **Learning and growth:** How you foster ongoing change and continuous improvement

### **Features:**

- A balanced scorecard is a performance metric used to identify, improve, and control a business's various functions and resulting outcomes.

# Management Science

---

- The concept of BSCs was first introduced in 1992 by David Norton and Robert Kaplan, who took previous metric performance measures and adapted them to include nonfinancial information.
- BSCs were originally developed for for-profit companies but were later adapted for use by nonprofits and government agencies.
- The balanced scorecard involves measuring four main aspects of a business: Learning and growth, business processes, customers, and finance.
- BSCs allow companies to pool information in a single report, to provide information into service and quality in addition to financial performance, and to help improve efficiencies.

## **Benefits of the Balanced Scorecard**

1. **Better Strategic Planning:** The Balanced Scorecard provides a powerful structure for creating and communicating organizational strategy.
2. **Better Alignment of Projects & Initiatives:** The Balanced Scorecard help organizations map their projects and initiatives to different strategic objectives, ensuring that the chosen projects and initiatives are tightly focused on delivering the best strategic results for the organization.
3. **Focused Performance Reporting:** The Balanced Scorecard lends itself well to the design of performance reports and dashboards. So, management and Board reporting focuses on the most important strategic issues and helps organizations monitor the execution of their plan.
4. **Improved Organizational Alignment:** The Balanced Scorecard enables companies to better align their organizational structure with strategic objectives. In order to execute any plan well, businesses need to ensure that all business units and support functions are working towards the same goals.

# Management Science

---

5. **Improved Process Alignment:** The best Balanced Scorecards help align organizational processes—such as budgeting, risk management, and analytics—with strategic priorities to create a truly strategy and data-driven organization.

## BUSINESS PROCESS RE-ENGINEERING

According to **Dr. Michael Hammer:**

*“Business Process Re-engineering is the fundamental rethinking and radical design of business processes to achieve dramatic improvements in critical, contemporary measures of performance such as cost, quality, service and speed.”*

**Business process re-engineering** is not just a change, but actually it is a dramatic change and dramatic improvements. This is only achieved through overhaul the organization structures, job descriptions, performance management, training and the most importantly, the use of IT i.e. Information Technology.

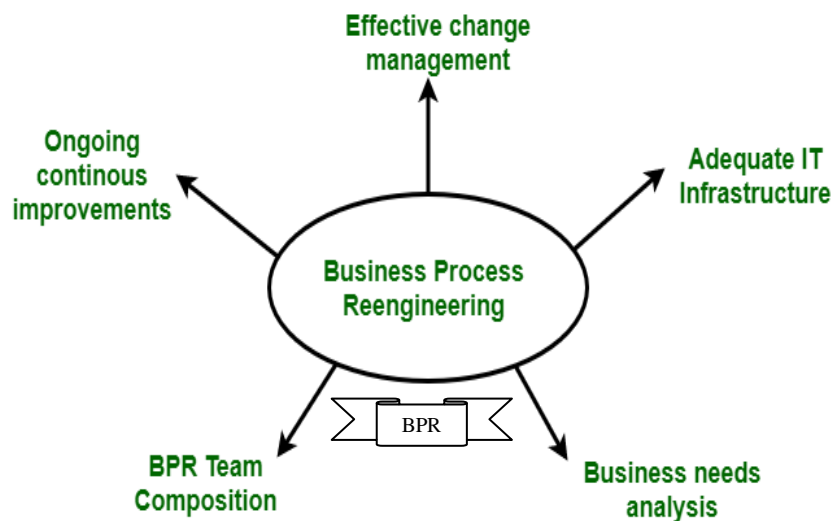

BPR projects have failed sometimes to meet high expectations. Many unsuccessful BPR attempts are due to the confusion surrounding BPR and how it should be performed. It becomes the process of trial and error.



## **Phases of BPR:**

There are seven different phases for BPR. All the projects for BPR begin with the most critical requirement i.e. communication throughout the organization.

1. Begin organizational change.
2. Build the re-engineering organization.
3. Identify BPR opportunities.
4. Understand the existing process.
5. Reengineer the process
6. Blueprint the new business system.
7. Perform the transformation.

## **Objectives of BPR:**

1. To dramatically reduce cost.
2. To reduce time requirements.
3. To improve customer services dramatically.
4. To reinvent the basic rules of the business e.g. The airline industry.
5. Customer satisfaction.
6. Organizational learning.

## **Challenges faced by BPR Process:**

All the BPR processes are not as successful as described. The companies that have start the use of BPR projects face many of the following challenges:

1. Resistance

2. Tradition
3. Time requirements
4. Cost
5. Job losses

## **Advantages of BPR:**

1. BPR offers tight integration among different modules.
2. It offers same views for the business i.e. same database, consistent reporting and analysis.
3. It offers process orientation facility i.e. streamline processes.
4. It offers rich functionality like templates and reference models.
5. It is flexible.
6. It is scalable.
7. It is expandable.

## **Disadvantages of BPR:**

1. It depends on various factors like size and availability of resources. So, it will not fit for every business.
2. It is not capable of providing an immediate resolution.

## **BENCHMARKING**

Benchmarking is an approach of setting goals and measuring productivity based on best industry practices. Benchmarking helps in improving performance by learning from best practices and the processes by which they are achieved.

# Management Science

---

Benchmarking is defined “*as the continuous, systematic process of measuring ones output and/or work processes against the toughest competitors or those recognized best in the industry.*”

## **Need of Benchmarking:**

1. Benchmarking helps organizations focus on the external environment and improve process efficiency.
2. Benchmarking promotes a climate for change by allowing employees to gain an understanding of their performance what they are achieving now and how they compare to others in order that they become aware of what they could achieve.

## **Reasons of Benchmarking:**

- 1. Defining Customer Requirements:** It is not based on history or gut feeling, perception and low fit but on the basis of market reality, objective evaluation and high conformance.
- 2. Establishing Effective Goals and Objectives:** It is not on the basis of lacking external focus, reactive response, and lagging industry but on the basis of credibility, inarguable, proactive and leading industry goals and objectives.
- 3. Developing True Measures of Productivity:** Without benchmarking this may be done by pursuing pet projects, strengths and weaknesses not understood on-route of least resistance. But with benchmarking this is carried out by solving real problems and understanding outputs of each decision based on the best industry practices.
- 4. Becoming Competitive:** This is not carried out on internally focused, evolutionary change, and low commitment. But it is done on the basis of concrete understanding of competition, new ideas of proven practices, technology and high commitment.

**5. Industry Best Practices to be Achieved:** This is also not done on methods not invented here, few solutions, average of industry progress and frantic catch up activity. But it is done on the basis of proactive search for change, many options, business practice breakthrough and superior performance.

### Types of Benchmarking

**1. Internal Benchmarking:** It involves looking within the organization to determine other departments, locations and projects which have similar activities and then defining the best practices amongst them. It involves seeking partners from within the same organization. For example- from business units located in different areas.

**2. External Benchmarking:** External benchmarking involves seeking help of outside organizations that are known to be best in class. External benchmarking provides opportunities of learning from those who are at the leading edge, although it must be remembered that not every best practice solution can be transferred to others. In addition, this type of benchmarking may take up more time and resource to ensure the comparability of data and information, the credibility of the findings and the development of sound recommendations.

**3. Generic Benchmarking:** Generic benchmarking involves comparing with organizations that have similar processes. It involves the comparison of an organization's critical business processes and operations against best practice organization that performs similar work or delivers similar services. For example- how do best practice organization process customer's orders? It extends the benchmarking process outside the organization and its industry to get inspiration from organizations in dissimilar industry.

**4. Functional Benchmarking:** This type of benchmarking is used when organizations look to benchmark with partners drawn from different business sectors or areas of activity to find ways of improving similar functions or work processes. This sort of benchmarking can lead to innovation and dramatic improvements.

**5. Competitive Benchmarking:** It involves examining the products, services and processes of competitors and then comparing them with their own. It involves the

comparison of competitors' products, process and business results with own. It requires that the company perform a detailed analysis of its competitors' products, services, and processes. Benchmarking partners are drawn from the same sector. However to protect confidentiality it is common for the companies to undertake this type of benchmarking through trade associations or third parties.

**6. Compatible Industry Benchmarking:** Compatible industry will include those companies that are not directly competing for the same customer. It make comparisons within a general industry category. For example- a company, which is manufacturing automobile spare parts, compares itself with another company which is manufacturing automobile accessories.

**7. Strategic Benchmarking:** It is similar to the process benchmarking in nature but differed in its scope and depth. It involves a systematic process by which a company seeks to improve their overall performance by examining the long-term strategies. It involves comparing high-level aspects such as developing new products and services, core competencies etc.

**8. Global Benchmarking:** It is a benchmarking through which distinction in international culture, business processes and trade practices across companies are bridged and their ramification for business process improvement are understood and utilized. Globalization and advances in information technology leads to use this type of benchmarking.

### **MATERIAL REQUIREMENT PLANNING (MRP)**

Industry is getting modern face day by day. The management function is adopting new techniques to improve overall productivity. Materials management is also accepting and implementing such modern techniques. Examples: MRP and ERP.

MRP is a simple system of calculating arithmetically the requirements of the input materials at different points of time based on the actual production plan. MRP can also be defined as a planning and scheduling system to meet time-phased materials requirements for production operations. MRP always tries to meet the delivery schedule of end products as specified in the master production schedule.

# Management Science

---

## MRP Objectives

- **Reduction in Inventory Cost:** By providing the right quantity of material at the right time to meet the master production schedule, MRP tries to avoid the cost of excessive inventory.
- **Meeting Delivery Schedule:** By minimizing the delays in materials procurement, production decision making, MRP helps avoid delays in production thereby meeting delivery schedules more consistently.
- **Improved Performance:** By streamlining the production operations and minimizing the unplanned interruptions, MRP focuses on having all components available at the right place in the right quantity at the right time.

**Components of MRP system:** A simple sketch of an MRP system is shown in the figure. It can be seen from the figure that an MRP system has three major **input components**:

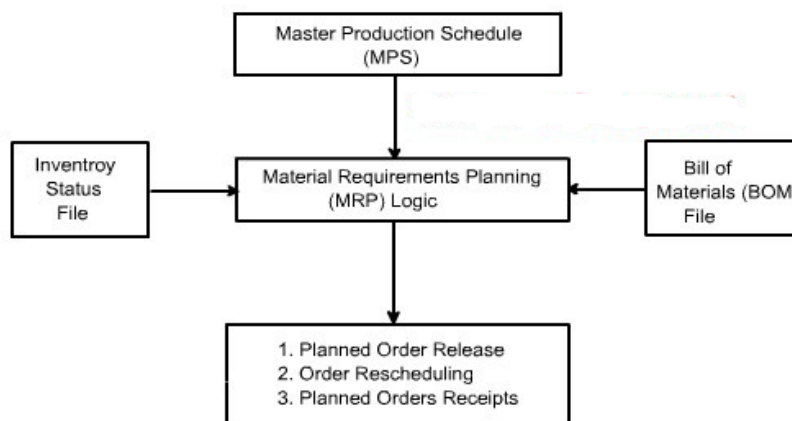

## **Functions of Material Requirements Planning:**

1. To ensure that material and components are available for production.
2. To ensure that final products are ready for dispatch.
3. To maintain minimum inventory.
4. To ensure the right quantity of material is available at the right time to produce the right quantity of products.
5. To ensure the planning of all manufacturing processes.
6. To reduce investment in work in process inventories.

## Input Files of MRP:

- **Master Production Schedule (MPS):** MPS is designed to meet the market demand (both the firm orders and forecasted demand) in the future in the taken planning horizon. MPS mainly depicts the detailed delivery schedule of the end products. However, orders for replacement components can also be included in it to make it more comprehensive.
- **Bill of Materials (BOM) File:** BOM represents the product structure. It encompasses information about all sub-components needed, their quantity, and their sequence of buildup in the end product. Information about the work centers performing buildup operations is also included in it.
- **Inventory Status File:** Inventory status file keeps an up-to-date record of each item in the inventory. Information such as item identification number, quantity on hand, safety stock level, quantity already allocated and the procurement lead time of each item is recorded in this file.

## Output of MRP:

- **Planned Orders Receipts:** This is the order quantity of an item that is planned to be ordered so that it is received at the beginning of the period under consideration to meet the net requirements of that period. This order has not yet been placed and will be placed in the future.
- **Planned Order Release:** This is the order quantity of an item that is planned to be ordered in the planned time period for this order that will ensure that the item is received when needed. Planned order release is determined by offsetting the planned order receipt by the procurement lead time of that item. Planned Order Release includes inventory forecast, purchase commitment reports, stock-out incidences, etc.
- **Order Rescheduling:** This highlights the need for any expediting, de-expediting, and cancellation of open orders, etc. in case of unexpected situations.

**MRP Outputs Reports:** The material requirements planning program generates a variety of outputs that can be used in the planning and management of plant operations.