

# VEMU INSTITUTE OF TECHNOLOGY:: P.KOTHAKOTA

Chittoor-Tirupathi National Highway, P.Kothakota, Near Pakala, Chittoor (Dt.), AP - 517112  
(Approved by AICTE, New Delhi and Affiliated to JNTUA, Anantapuramu )



**DEPARTMENT OF MECHANICAL ENGINEERING**

**ENGINEERING WORKSHOPLAB - 20A03202**

**B.TECH : I BTECH- I&II SEM**

**Prepared By**

**Mr. G. SUDARSANA REDDY**



# VEMU INSTITUTE OF TECHNOLOGY

**Steel rule:**

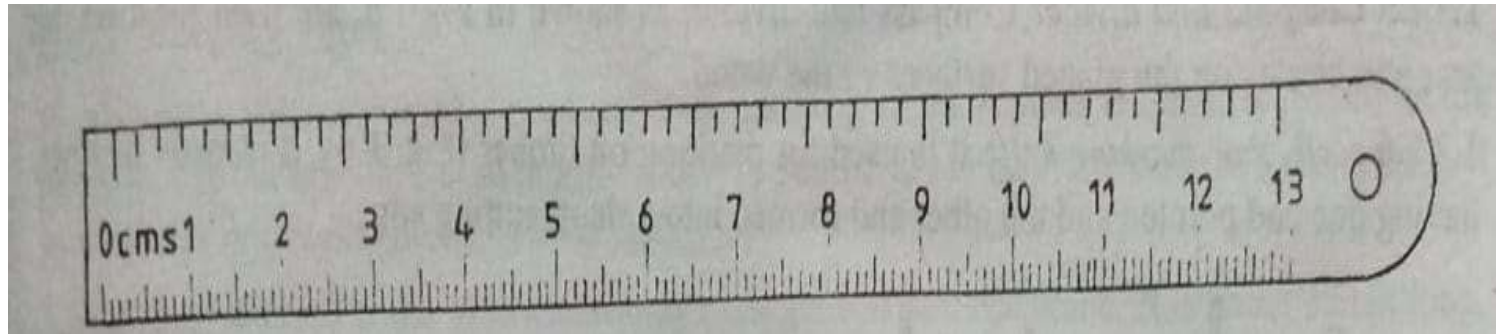

**Steel tape:**

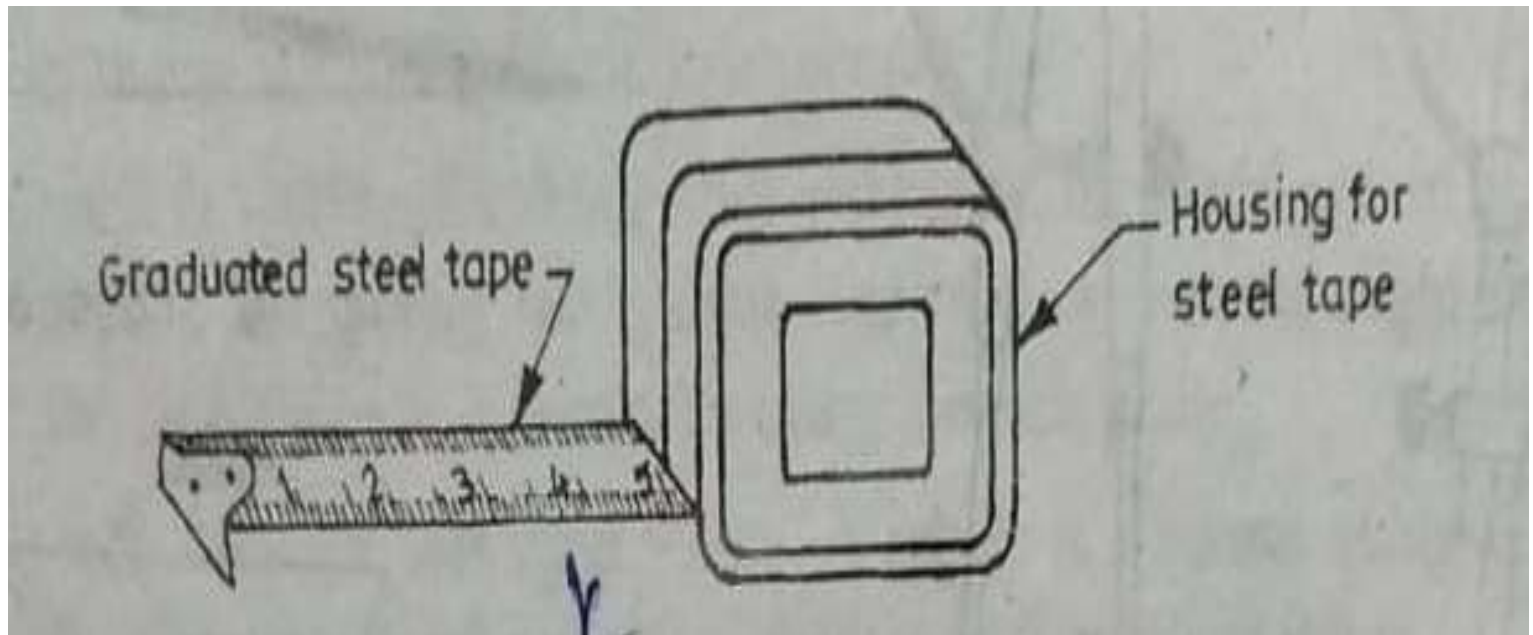



## Marking and Mortise gauge

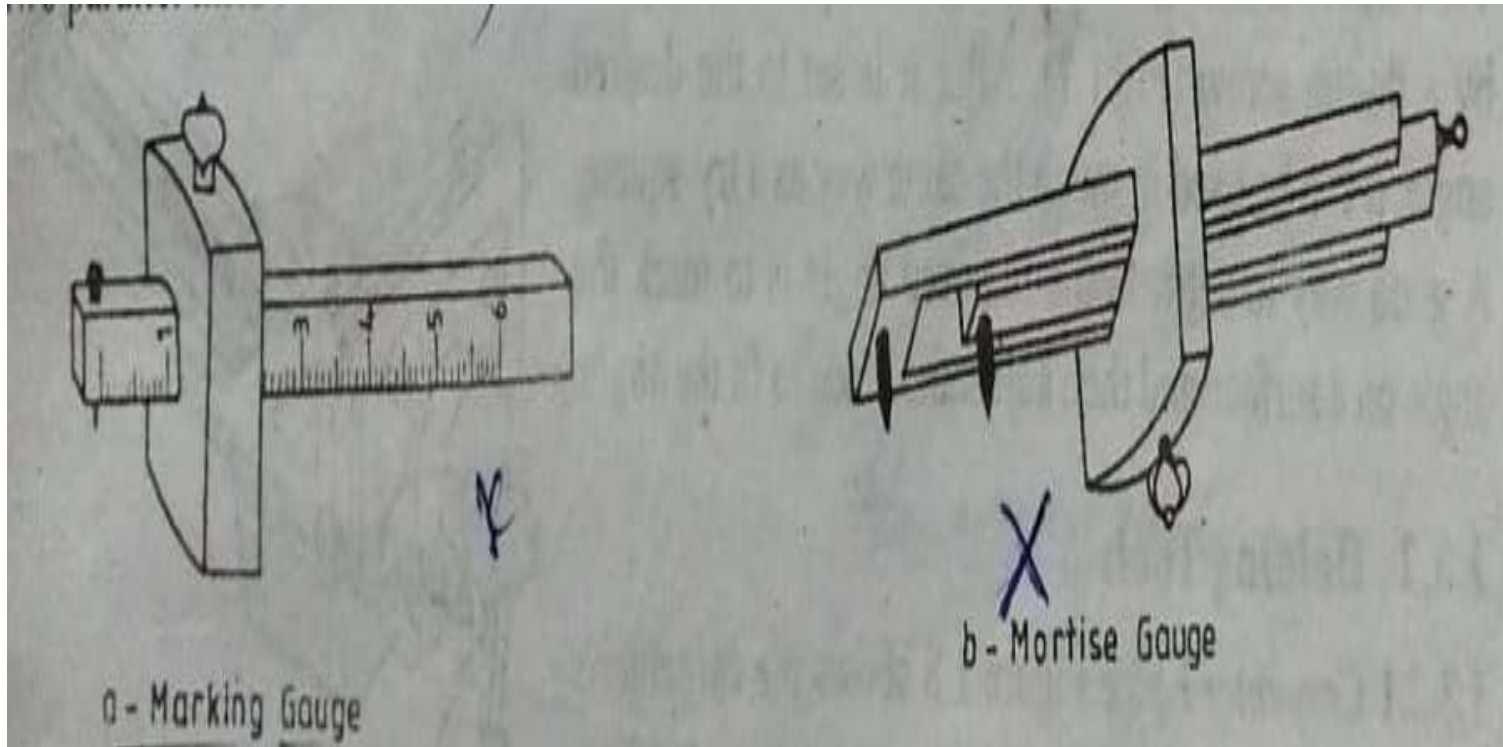



## Try – Square:

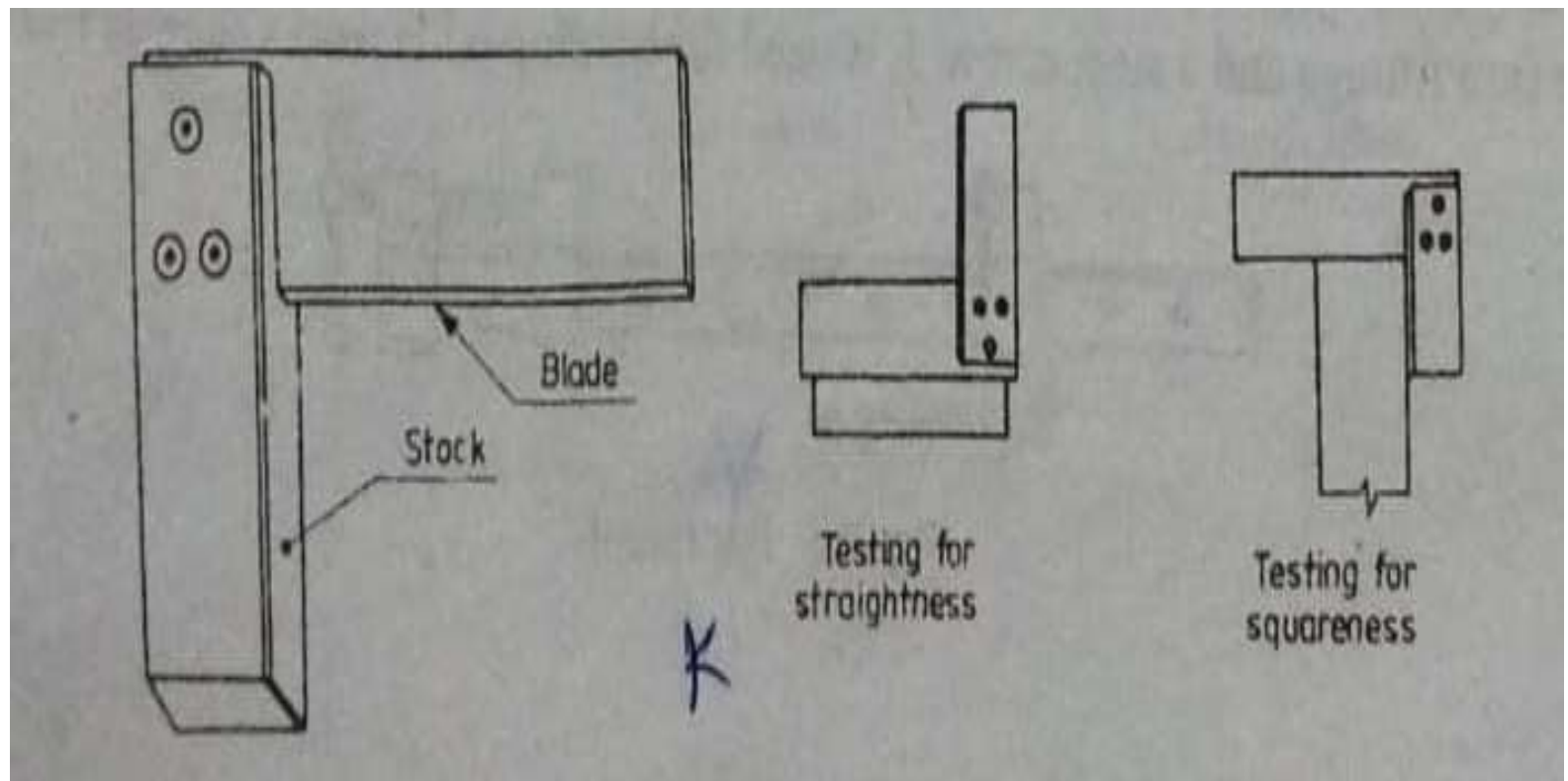



# Planing Tools:

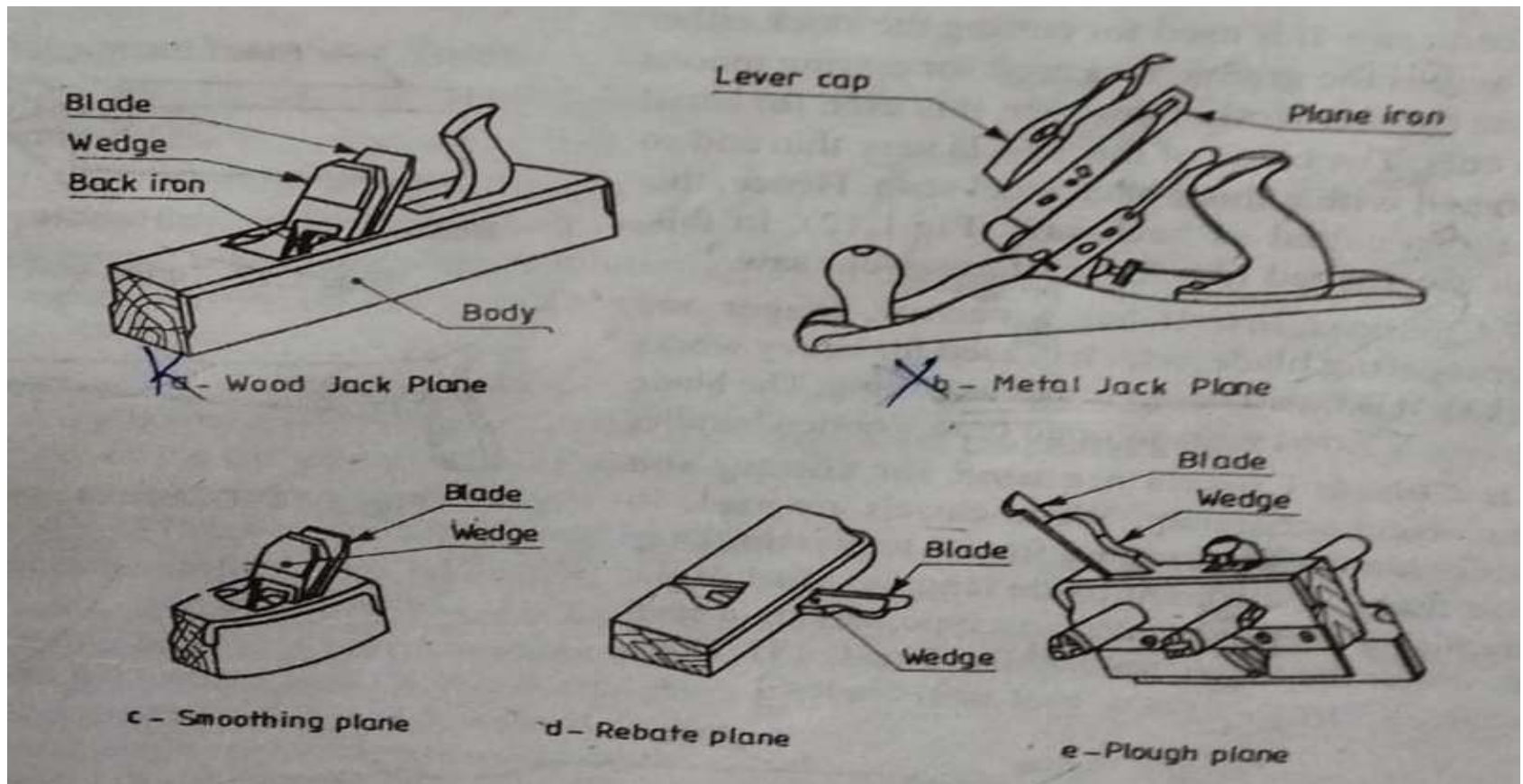



## Cross- cut and rip saw:

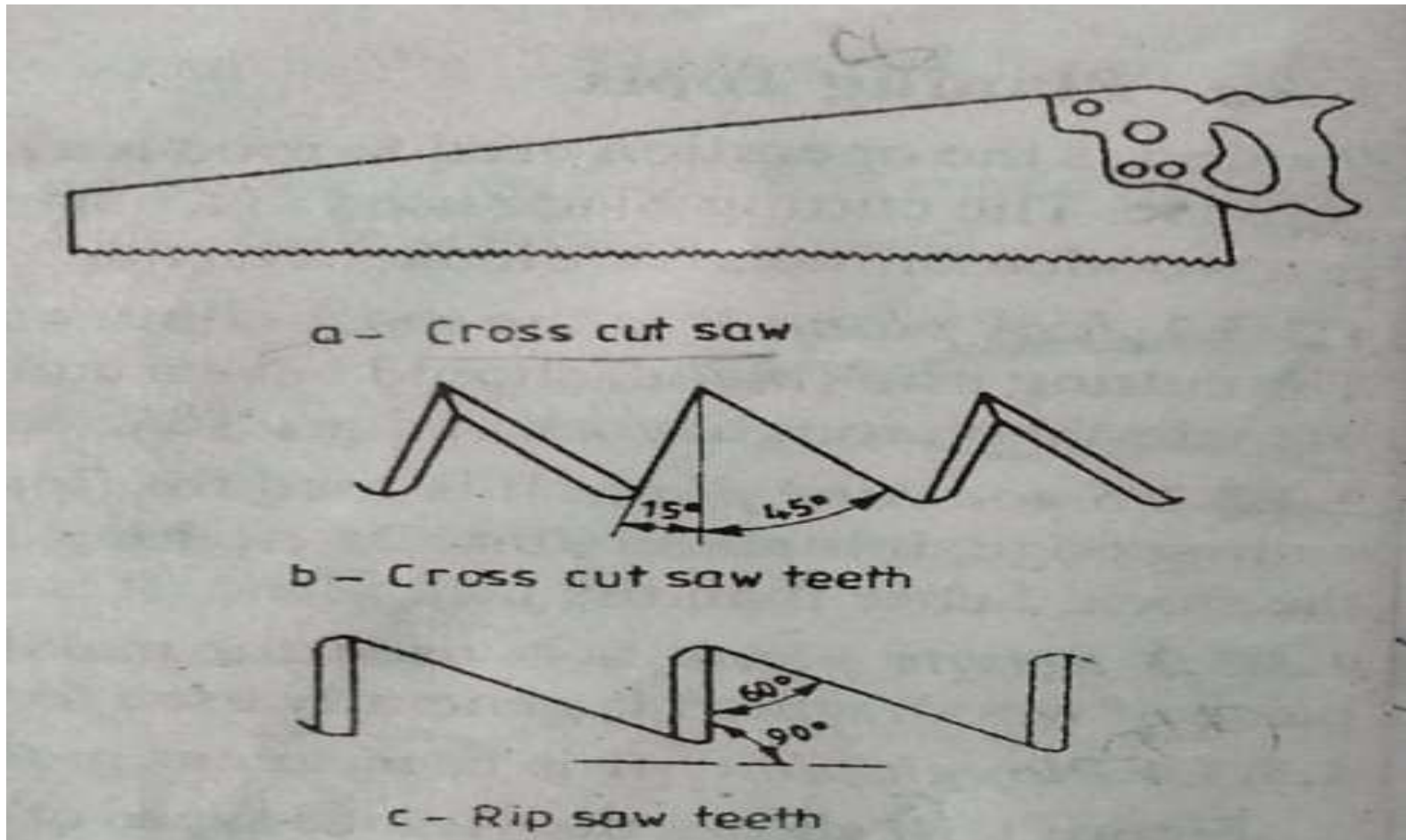



## Tenon saw:

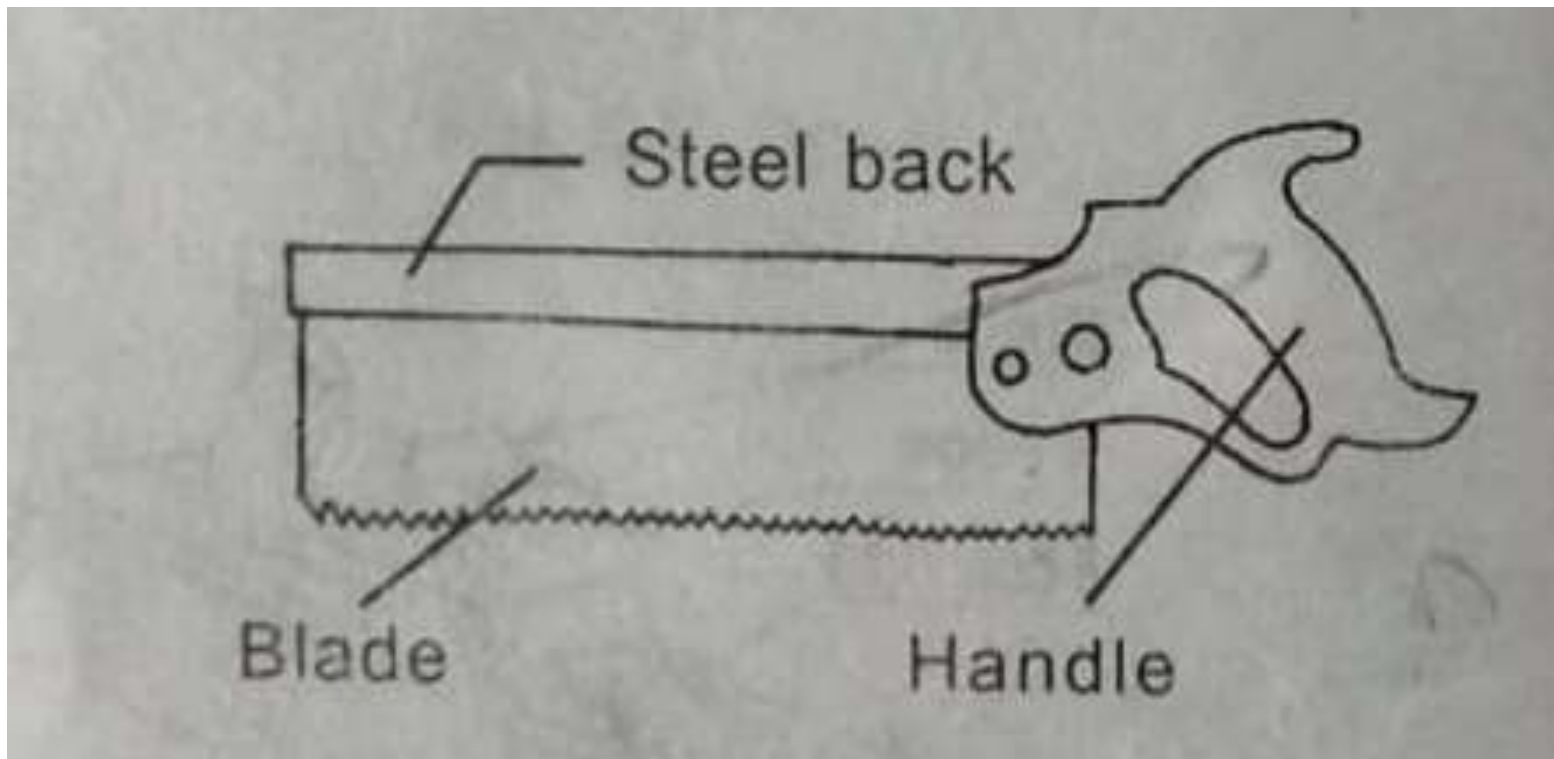



## Compass saw:

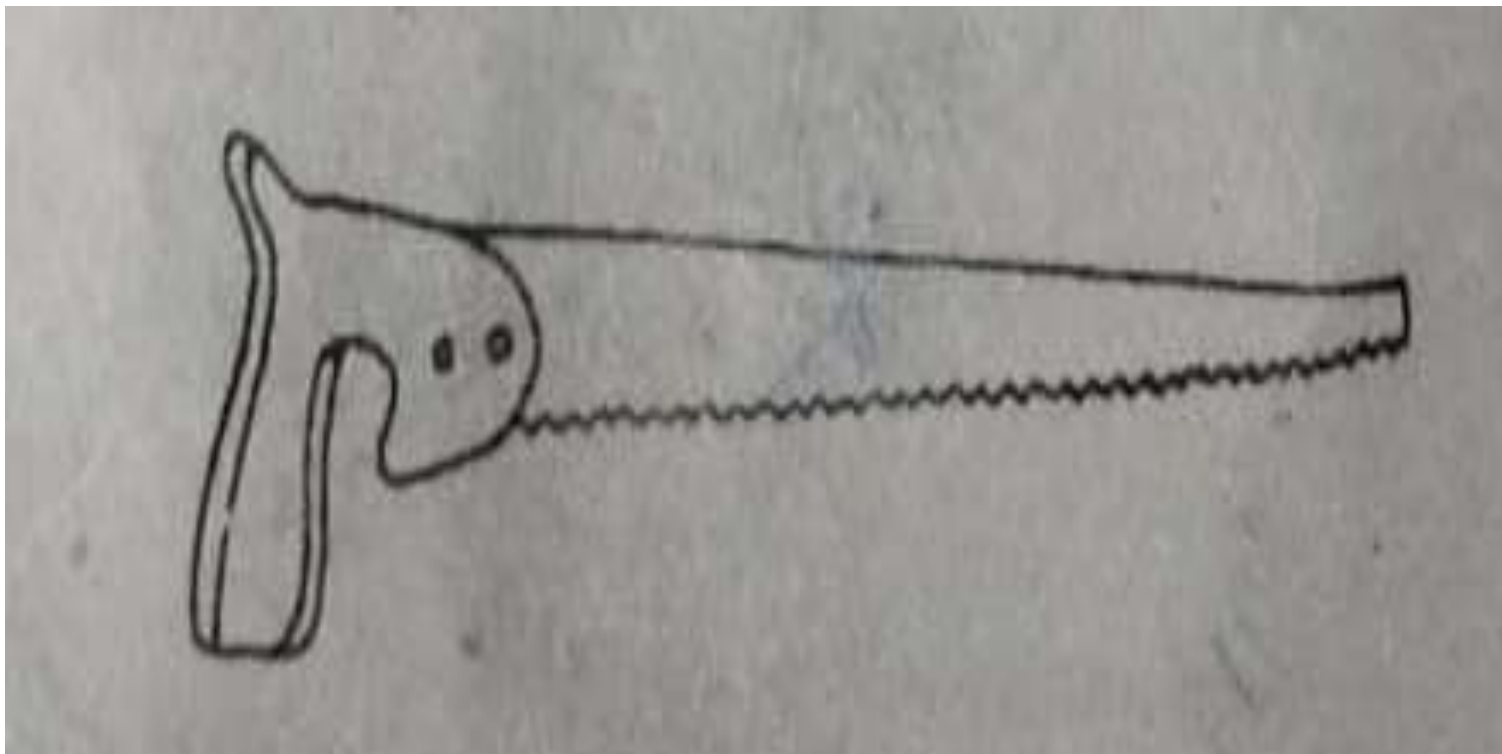





## Chisels:

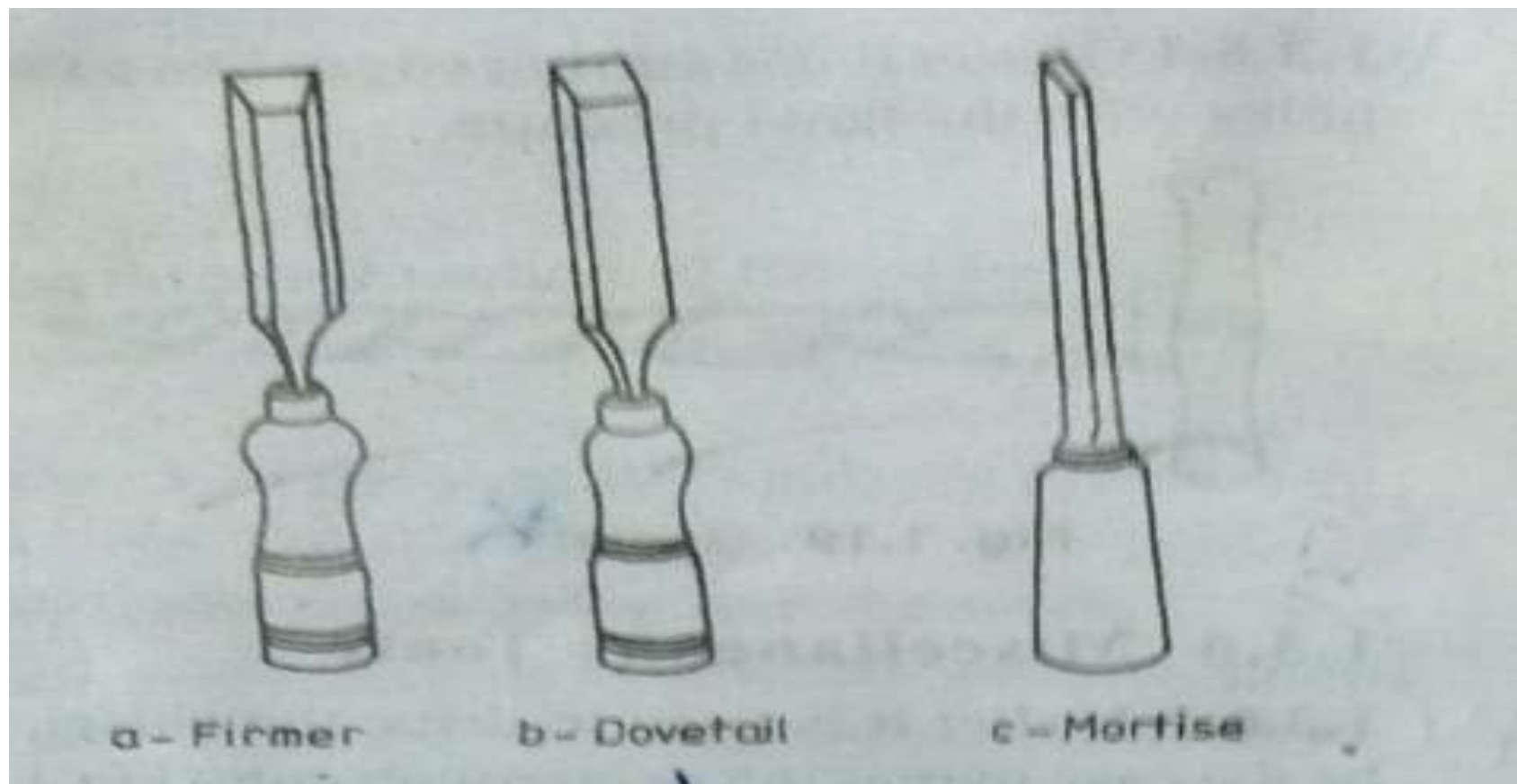



## Carpenter's brace:

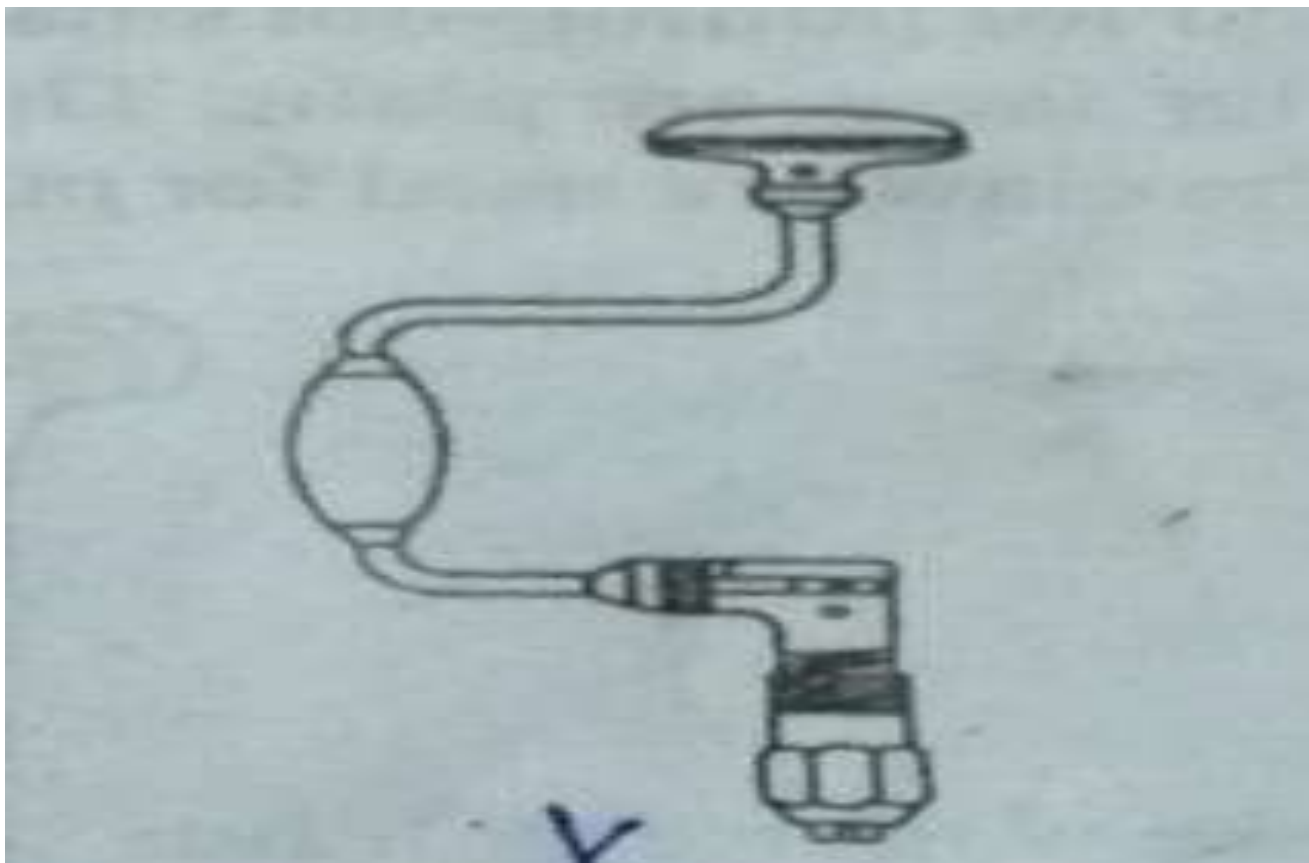



## Auger bit:

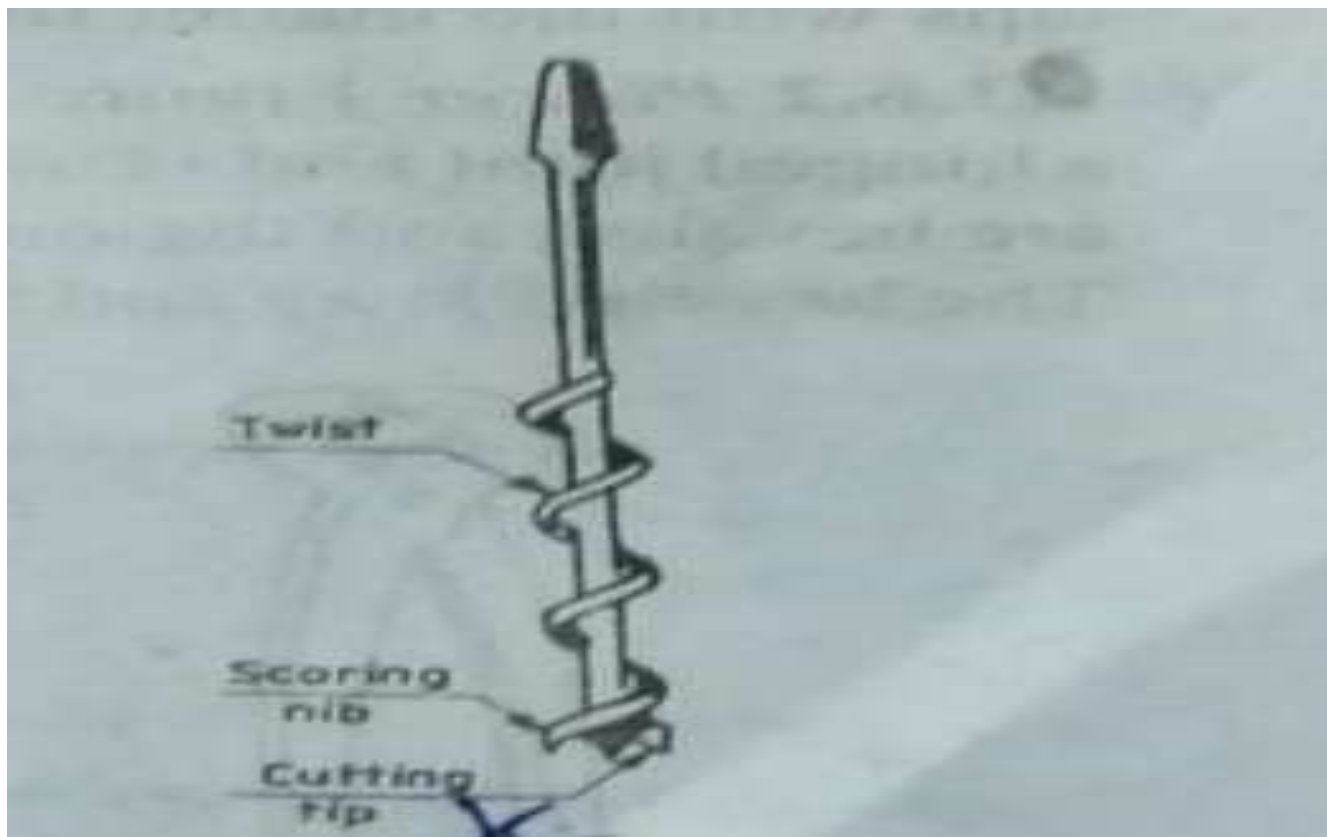



## Hand drill:





# 3 phase-4 wire supply:

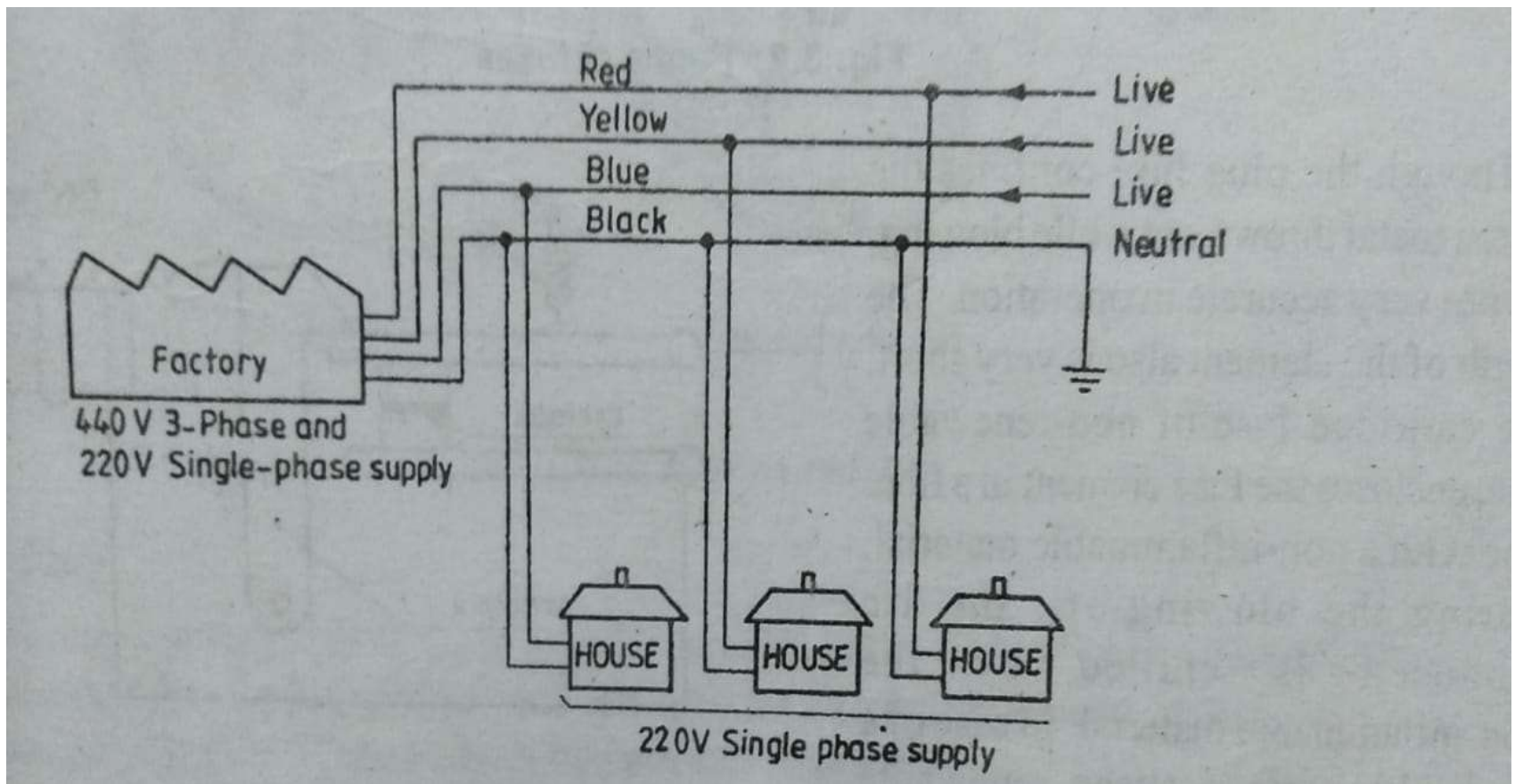



# Circuit symbols for electric items (contd.);

No.	Description	Symbol	S. No.	Description	Symbol
1	Main switch (Light)		15	Single tube light	
2	Main switch (Power)		16	Double tube light	
3	Meter		17	Bell	
4	One way switch		18	Buzzer	
5	Two way switch		19	Horn	
6	Lamp		20	Siren	
7	Two pin socket 5 Amp.		21	Ceiling fan	
8	Two pin socket with switch 5 Amp.		22	Bracket fan	
9	Three pin socket with switch 5 Amp.		23	Exhaust fan	
10	Three pin socket 15 Amp.		24	Fan regulator	
11	Three pin socket with switch 15 Amp.		25	Earth	
12	Bell push		26	Heater	
13	Single light pendent		27	Fire alarm push	
14	Batten lamp holder		28	Fire alarm bell	



## Bench vice:

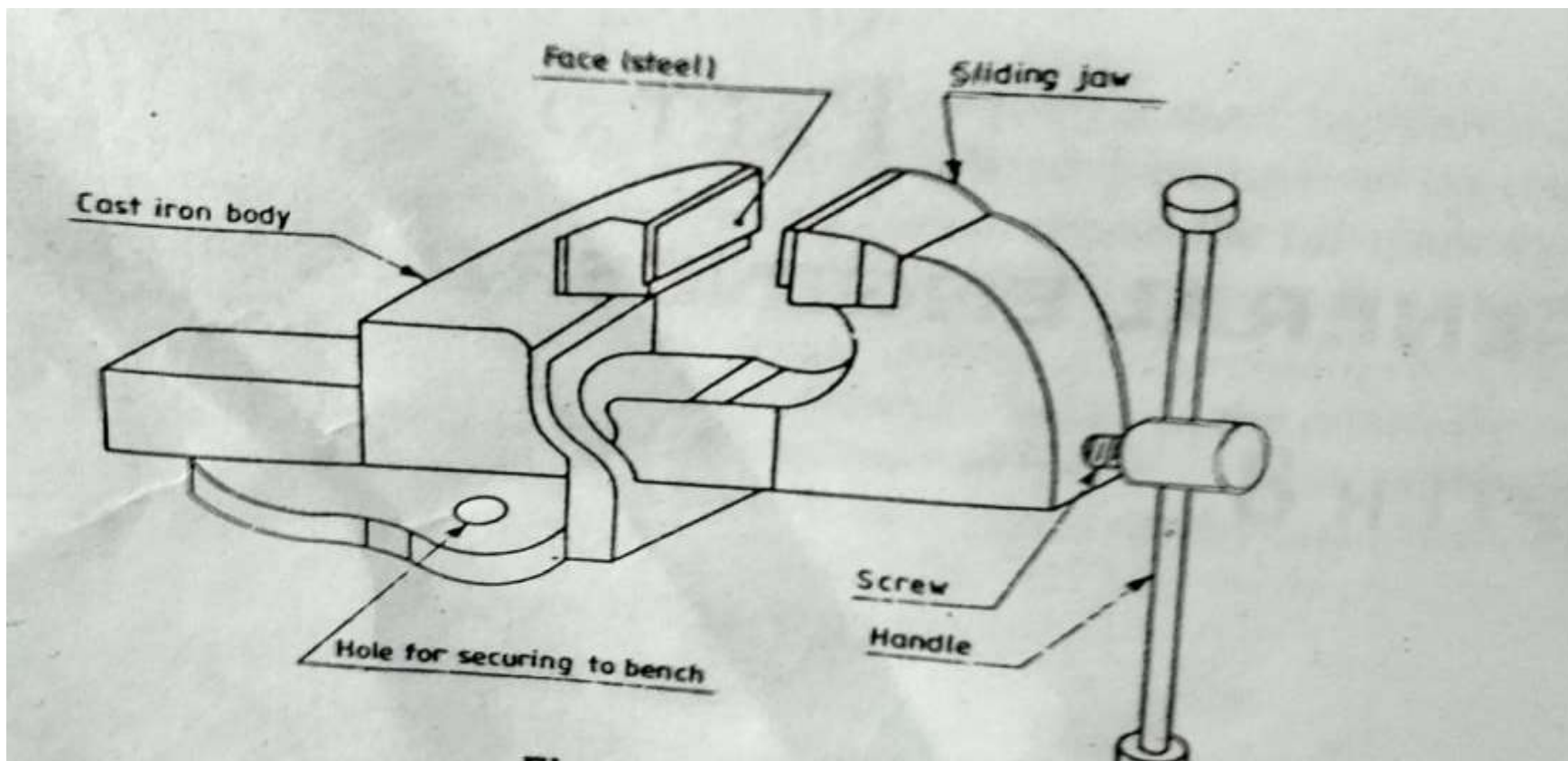



## Try – square:

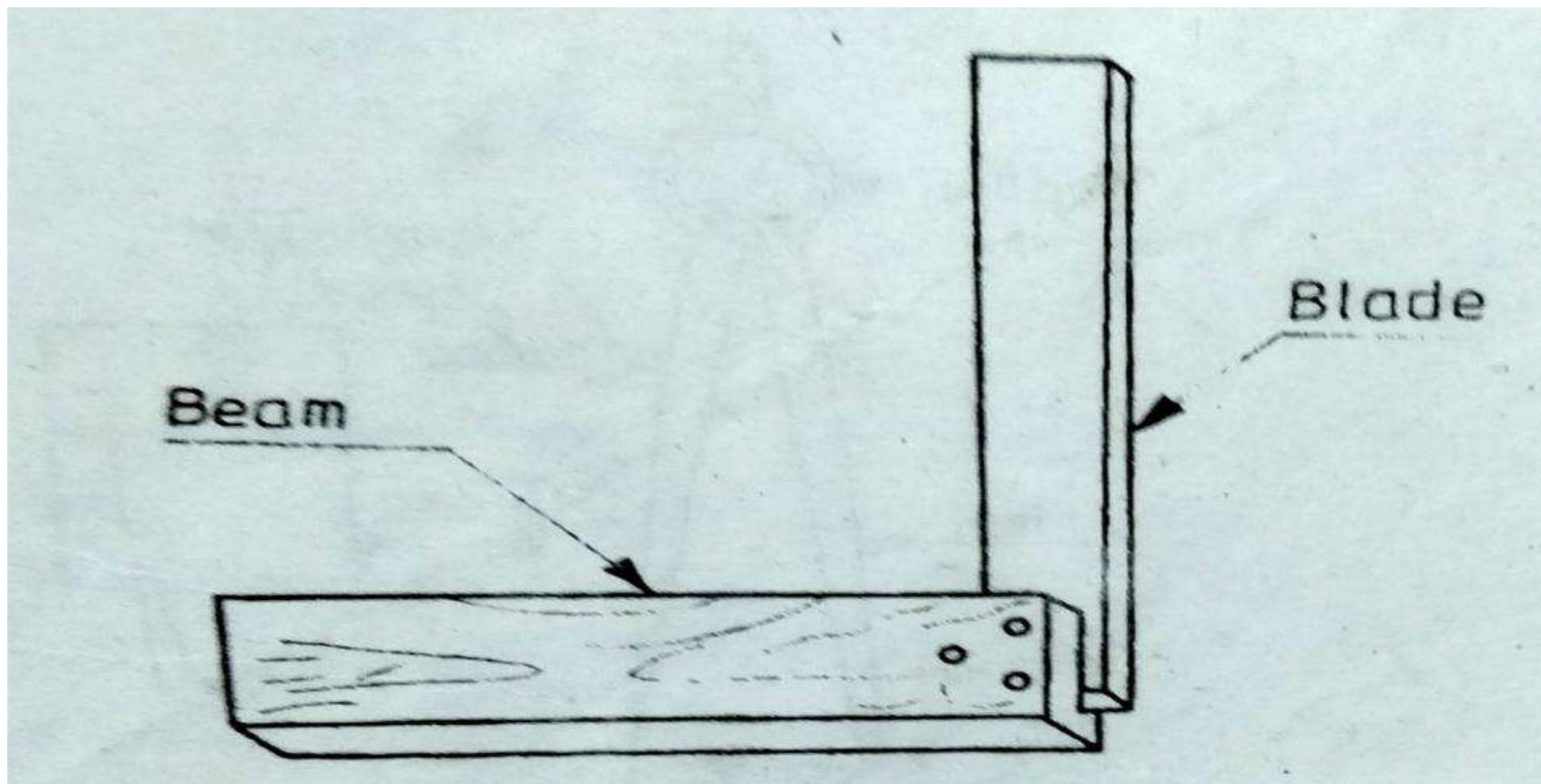





## Hand file:

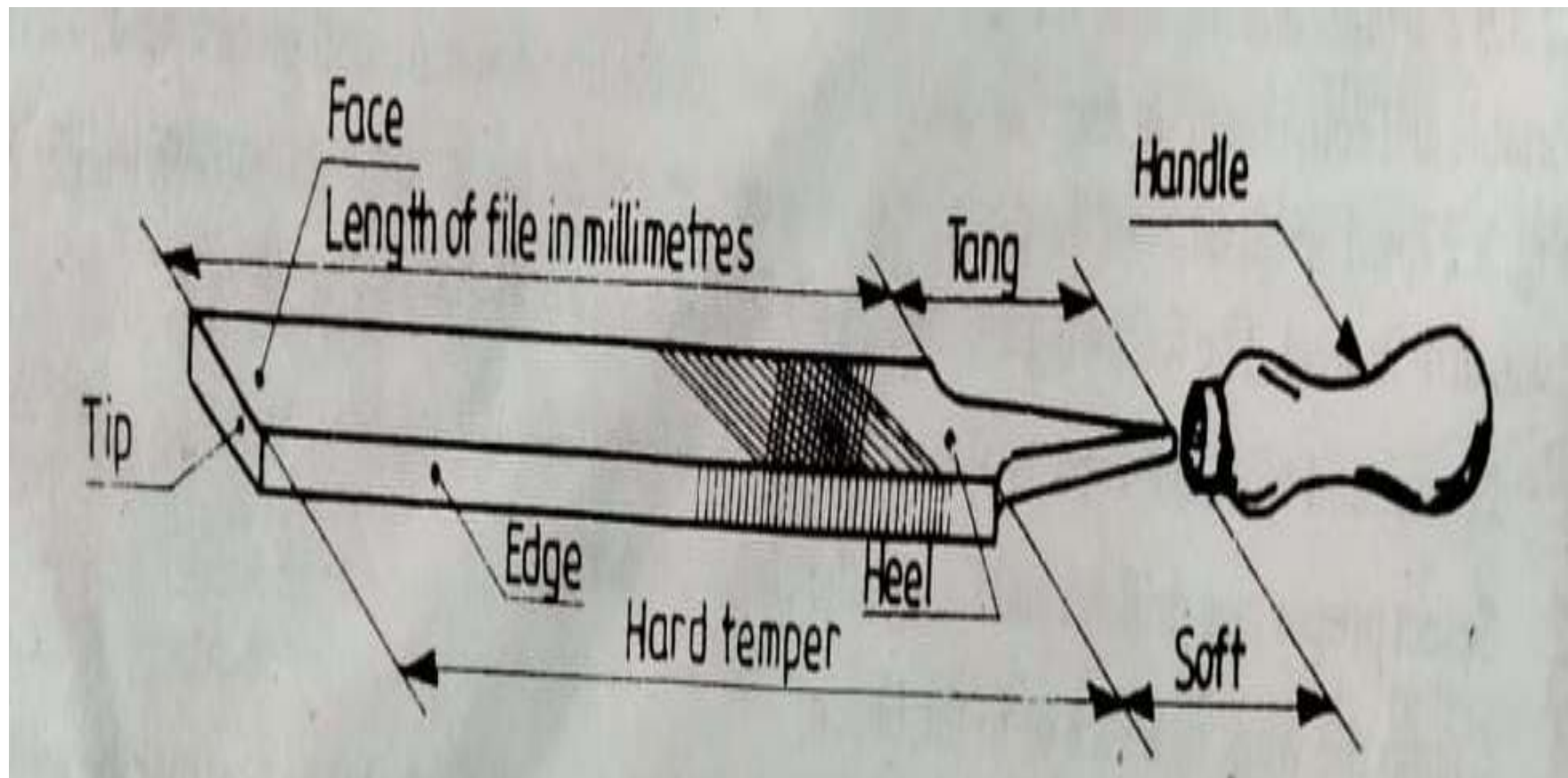



## Types of files:

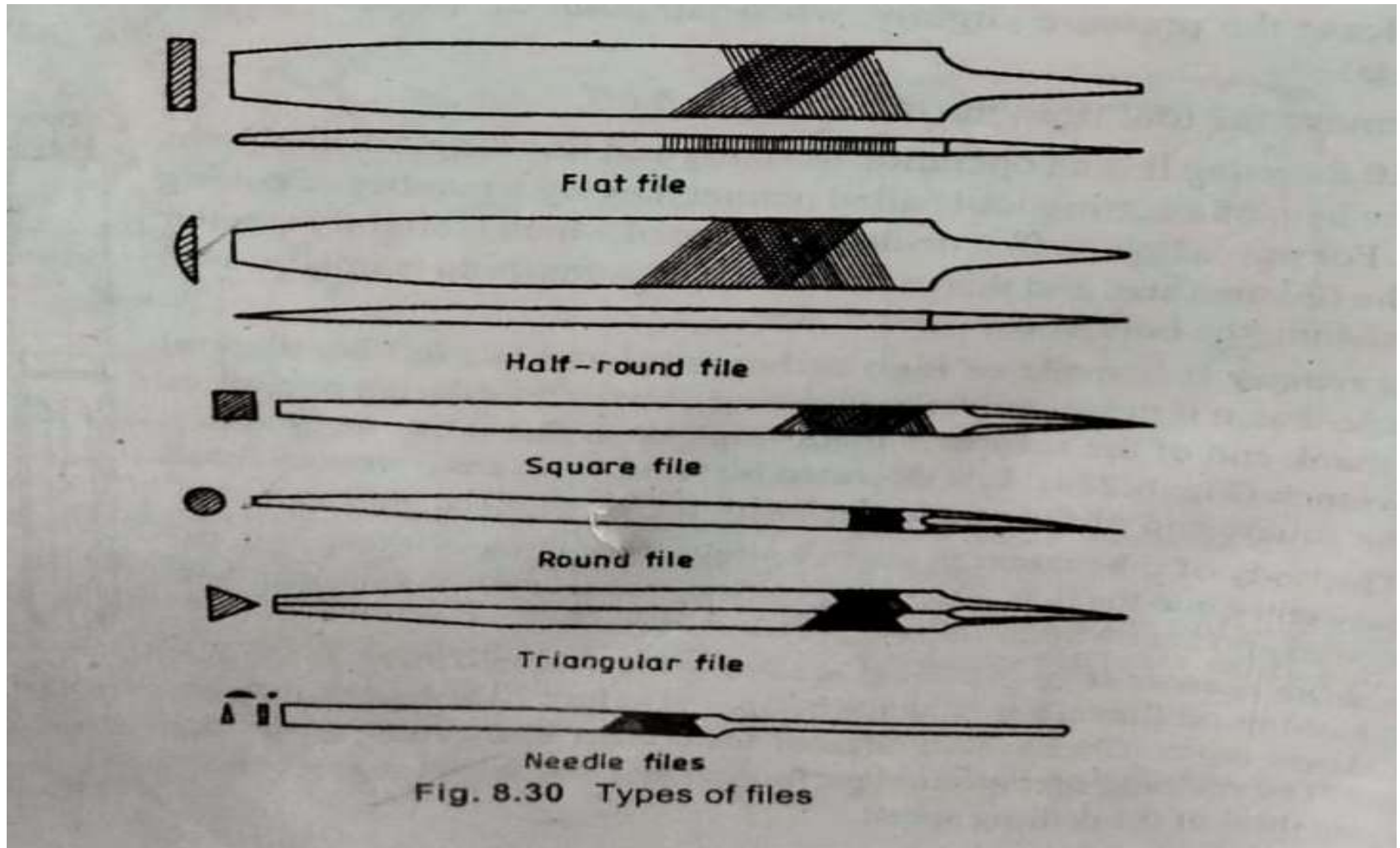



## Standard wire gauge:

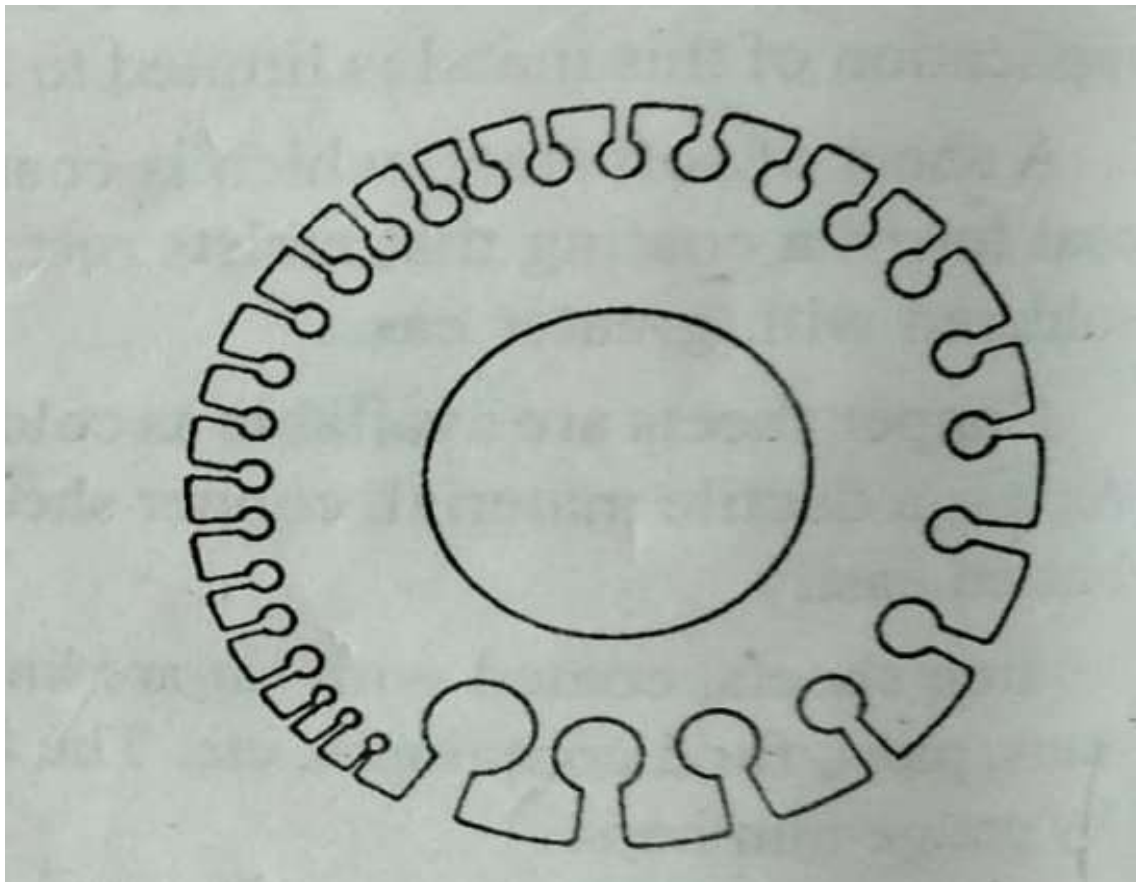



## Stakes:

